

4-Site™

Assembly Manual



Specifications

Wingspan:	32 in (823mm)
Length:	37 in (940mm)
Wing Area:	397 sq in (25.5 sq dm)
Weight w/o Battery:	5.0–5.75 oz (142–163 g)
Weight w/Battery:	6.0–6.5 oz (170–184 g)

E-flite®
ADVANCING ELECTRIC FLIGHT

Designed by: David Payne

Table of Contents

Introduction	2
Important Warranty Information	2
Using the Manual	2
Product Registration	2
Contents of Kit/Parts Layout	2
Recommended Radio Equipment	3
Important Information About Motor Selection	3
Outrunner Setup (E-flite)	3
Required Tools and Adhesives	3
Optional Accessories	3
Note on Lithium Polymer Batteries	3
Fuselage Construction	4
Wing Installation	7
Carbon Bracing Installation	9
Landing Gear Installation	11
Motor Installation	13
Control Horn Installation	14
Radio and Linkage Installation	16
Final Assembly	21
Airbrake Assembly (Optional)	22
Control Throws	23
Center of Gravity	23
Preflight	24
Range Test Your Radio	24
Safety Do's and Don'ts for Pilots	24
Flying Your 4-Site	24
Warranty Information	25
Instructions for Disposal of WEEE by Users in the European Union	26
2008 Official Academy of Model Aeronautics Safety Code	26

Introduction

Thank you for purchasing the E-flite® 4-Site™ F3P. The 4-Site is an attractive, easy-to-assemble, flat foam model that offers incredible precision and aerobatic flight characteristics. Constructed primarily of 3mm Depron foam, the 4-Site also offers a high level of prefabrication, including pre-beveled parts, pre-hinged control surfaces and a highly visible, pre-printed trim scheme. The lightweight, laser-cut Depron foam construction, carbon fiber support rods and carbon fiber motor mount set the standard for quality, durability and performance. The 4-Site also includes two different sets of speed brakes for optimal personalized flying styles. For anyone looking for an extremely lightweight, indoor foamie that excels in precision aerobatic flight and is easy to assemble, the 4-Site flies over the competition.

Important Warranty Information

Please read our Warranty and Liability Limitations section on Page 25 before building this product. If you as the Purchaser or user are not prepared to accept the liability associated with the use of this Product, you are advised to return this Product immediately in new and unused condition to the place of purchase.

Using the Manual

This manual is divided into sections to help make assembly easier to understand, and to provide breaks between each major section. In addition, check boxes have been placed next to each step to keep track of its completion. Steps with a single circle (○) are performed once, while steps with two circles (○○) indicate that the step will require repeating, such as for a right or left wing panel, two servos, etc.

Remember to take your time and follow the directions.

Product Registration

Register your product online at:
www.e-fliterc.com/register/

Contents of Kit/Parts Layout

EFL1201	Motor Mount/Firewall
EFL1202	Carbon Pushrod Set
EFL1203	Carbon Bracing and Landing Gear
EFL1204	Wheel Pants
EFL1180	Pushrod Supports (Wood)
EFL1181	Landing Skids, 2.5mm

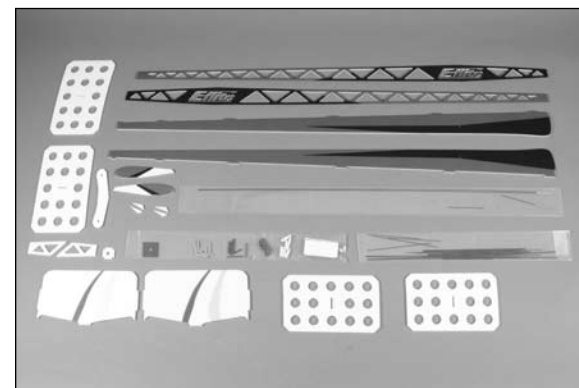

Recommended Radio Equipment

You will need a minimum 4-channel transmitter, receiver, and three servos. You can also choose to purchase a complete radio system. If you are using an existing transmitter, just purchase the other required equipment separately. We recommend the crystal-free, interference-free Spektrum™ DX6i 2.4GHz DSM® 6-channel system. If using your own transmitter, we recommend the 6.0 Gram Super Sub-Micro Digital Programmable Servos from Spektrum.

If you own the Spektrum DX6i radio, just add the AR6300 DSM2™ 6-channel receiver and three Spektrum 6.0 Gram Super Sub-Micro Digital Programmable Servos.

Transmitter and Receiver

SPM6600 DX6i 6-Channel DSM2 without Servos, Mode 2

Or Purchase Separately

SPMAR6300F AR6300 DSM2 Nanolite 6-Channel Receiver FlightPack with four DSP60J servos (only three servos are required for the 4-Site)

Or

SPMDSP60 6.0 Gram Super Sub-Micro Digital Prog Servo (3)
SPMAR6300 AR6300 DSM2 Nanolite 6-Channel Receiver, Air

Important Information About Motor Selection

We recommend the E-flite® Park 250 Brushless Outrunner Motor 2200Kv (EFLM1130) to provide you with lightweight precision F3P performance.

Outrunner Setup (E-flite)

EFLM1130 Park 250 Brushless Outrunner Motor, 2200Kv
EFLA1010 10-Amp Pro Brushless ESC
GWSEP8040B 8x4 Direct Drive Propeller
THP3502SJPL2 350mAh 2-Cell 7.4V 20C Pro Lite V2 Li-Po, JST

Required Tools and Adhesives

Tools & Equipment

Clear tape Felt-tipped pen
T-pin Hobby knife (#11 blade)
Low-tack tape Low-temperature glue gun
Round file Ruler
Sandpaper Side cutters
Soldering iron Square
Flat blade screwdriver, small
Phillips screwdriver: #0, #1

Adhesives

Foam-safe CA and Activator (EFLA208)
Thin CA

Optional Accessories

EFLA110 Power Meter
EFLC3005 Celectra™ 1–3 Cell Li-Po Charger
EFLC505 Intelligent 1- to 5-Cell Balancing Charger

Note on Lithium Polymer Batteries



Lithium Polymer batteries are significantly more volatile than alkaline or Ni-Cd/Ni-MH batteries used in RC applications. All manufacturer's instructions and warnings must be followed closely. Mishandling of Li-Po batteries can result in fire. Always follow the manufacturer's instructions when disposing of Lithium Polymer batteries.

E-tips

During the course of building your model we suggest that you use a soft base for the building surface. Such things as a foam stand, large piece of bedding foam or a thick bath towel will work well and help protect the model from damage during assembly.

E-tips

The most important part of building your model is guaranteeing that it is straight when completed. A flat work surface and square will be the most important items during this build.

Fuselage Construction

Required Parts

Main fuselage Stabilizer
Depron firewall Left horizontal fuselage
Right horizontal fuselage
Left upper diagonal brace
Right upper diagonal brace
Left lower diagonal brace

Required Tools and Adhesives

Square Foam-safe CA

E-tips

If you lay the fuselage on the edge of a flat surface so that the landing gear doubler is hanging off of the edge and just the top half above that is on the table it will allow you to keep the fuselage very straight during the first steps.

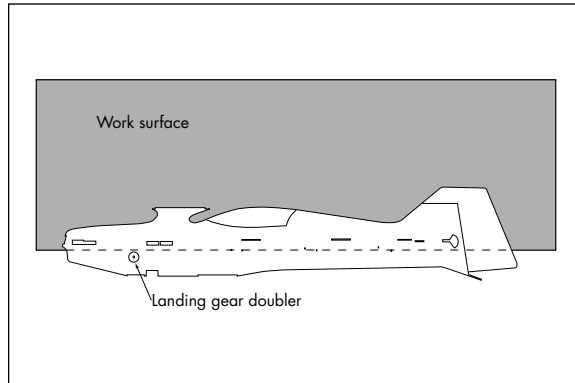

1. Locate the left horizontal fuselage and main fuselage. The left horizontal fuselage will be printed on top and white on the bottom. Test fit the horizontal fuselage to the main fuselage. Check that the horizontal fuselage lines up at the front with the main fuselage.

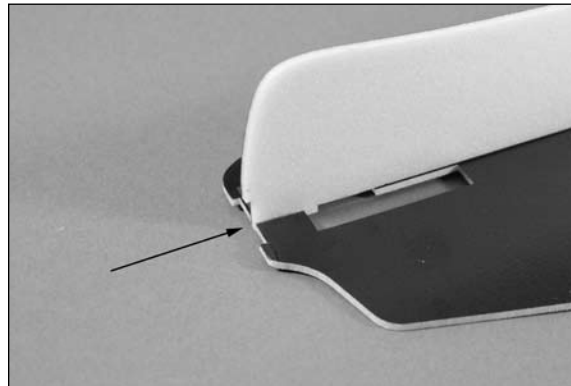
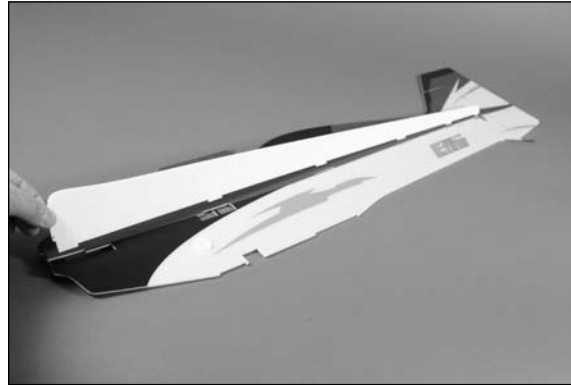

2. When gluing the horizontal fuselage to the main fuselage, do not apply glue toward the tail after the last tab. This is necessary to properly install the horizontal stabilizer.

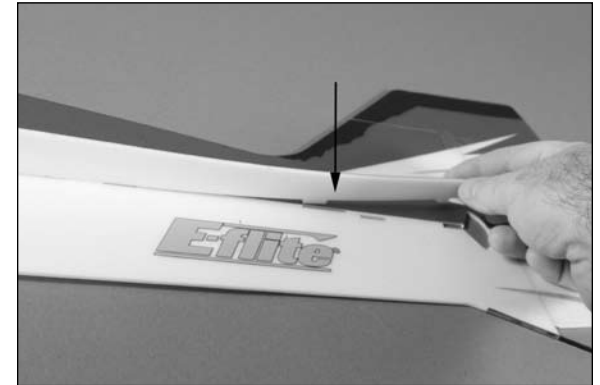

3. Remove the horizontal fuselage from the main fuselage. Apply a bead of foam-safe CA to the left horizontal fuselage where it contact the main fuselage. Do not apply CA to the rear section of the horizontal fuselage as noted in the previous step.



- 4. Position the horizontal fuselage on the main fuselage, again making sure that they line up at the front. Use a square at multiple points on the fuselage from nose to tail to guarantee the horizontal fuselage is square to the main fuselage. Check square from both the top and bottom side of the fuselage. Allow the CA to fully cure before proceeding.

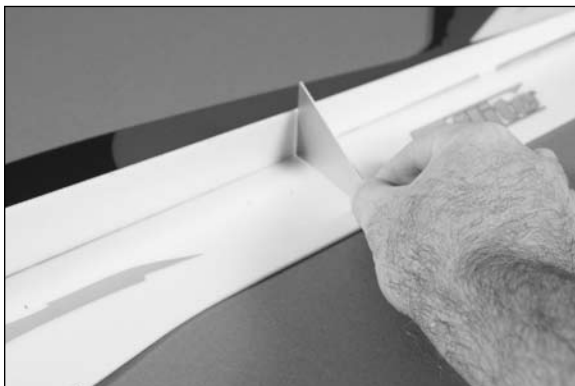

- 5. Position the left upper diagonal brace as shown. Use the alignment point in the photo to properly position the brace. **The brace will just cover the holes when aligned properly.** Also make sure it is aligned at the front of the fuselage. The angle of the brace will be 45° to the fuselage sides and will be equal distance on both the horizontal and vertical fuselage. Use foam-safe CA to glue the diagonal brace to the main and horizontal fuselage. Do not apply CA to the rear section of the diagonal brace, similar to that of the horizontal fuselage.

E-tips

You can temporarily use the foam firewall to locate and mark the angle of the diagonal brace at the front of the fuselage.

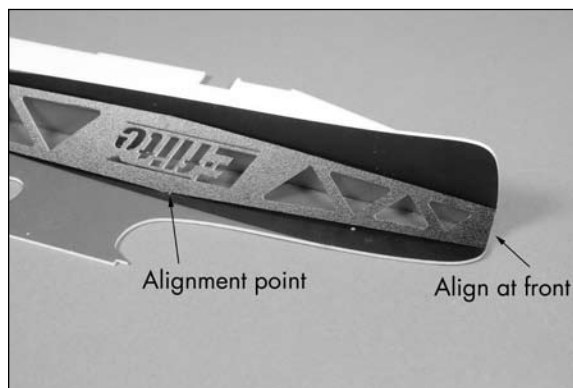

E-tips

Make sure to use a square on the bottom side of the horizontal fuselage when gluing the diagonal brace to the vertical and horizontal fuselage.

E-tips

Make sure that while you are gluing the diagonal brace to the fuselage you do not put a lot of pressure on the assembly. You could create a warp in the fuselage assembly.

- 6. Use foam-safe CA to glue the left lower diagonal brace as shown.

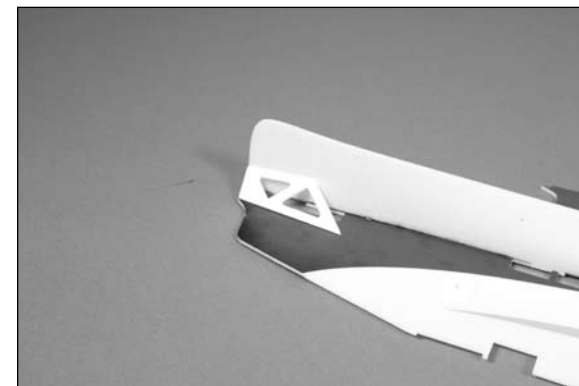
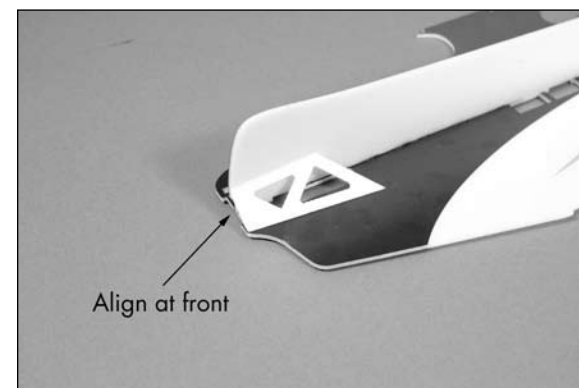

- 7. Locate the horizontal stabilizer. Note the coloring scheme on the top of the stabilizer. Carefully fold the elevator on the stabilizer as shown so it can be installed into the fuselage.

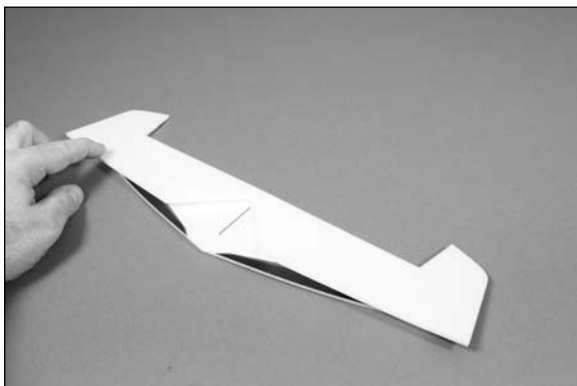

- 8. Slide the folded horizontal stabilizer into the fuselage. Unfold the elevator and position the stabilizer, but do not apply any glue to the stabilizer at this time.

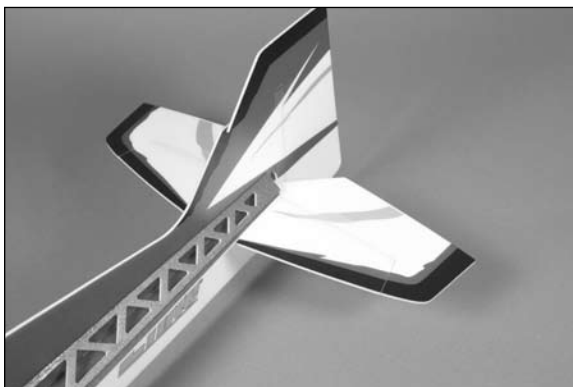

- 9. Repeat Steps 1 through 5 to install the right upper diagonal fuselage brace with foam-safe CA. Again, make sure to work slowly and use a square to keep the alignment of your fuselage in check. You will not glue the lower right diagonal brace until later in the build.



- 10. Locate the Depron firewall. Note the alignment points on the firewall and how they relate to fuselage. The alignment points are located on the top and left (as viewed from the front of the fuselage) as up and right thrust are built into your model. Use foam-safe CA to install the Depron firewall in the fuselage.

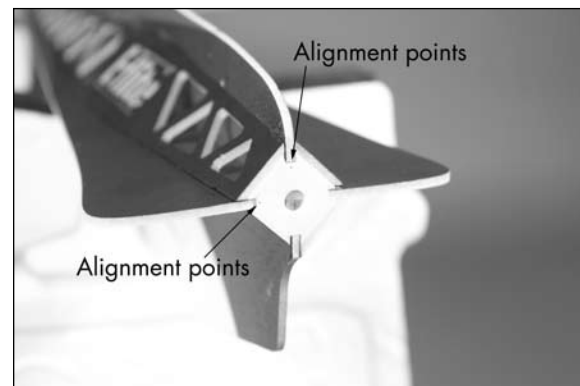

Wing Installation

Required Parts

Fuselage assembly Top wing
Bottom wing Outer strut (2)

Required Tools and Adhesives

Square Foam-safe CA

- 1. Locate the bottom wing.

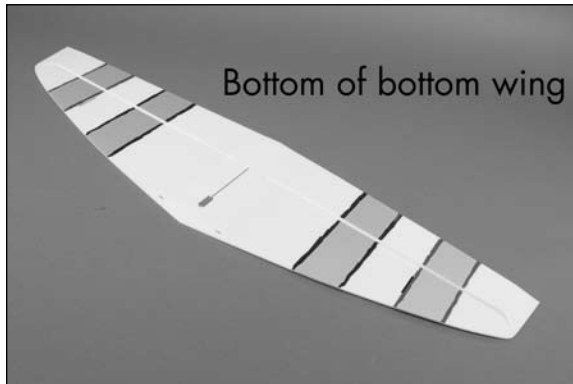
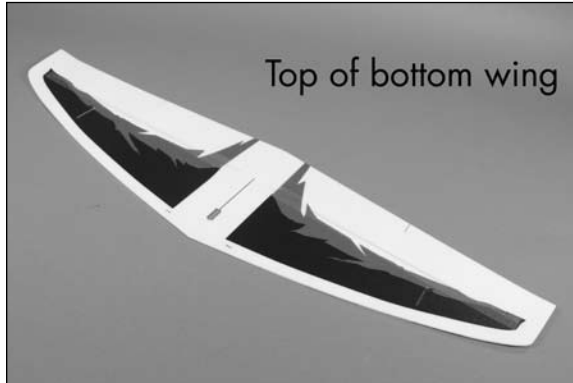

- 2. Test fit the fuselage into the bottom wing as shown. Make sure the tabs from the fuselage are flat when inserted into the bottom wing. If not, you may induce an airfoil resulting in unwanted flight characteristics.

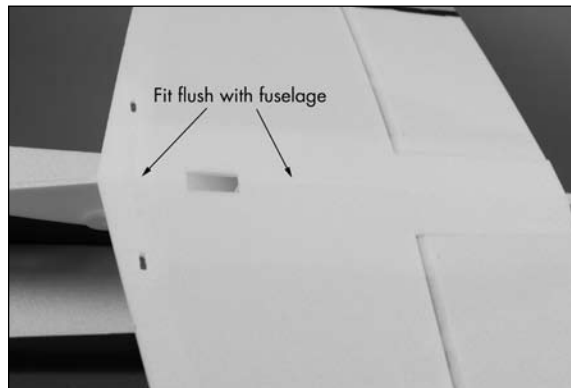
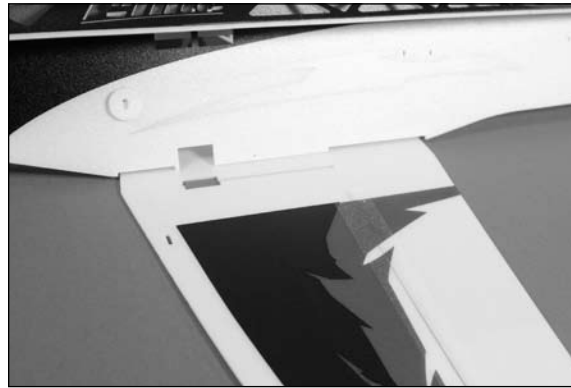

E-tips

If the tail of your airplane is hanging off of the table when you are mounting the bottom and top wing it will allow the assembly to lay perfectly flat against the joint.

- 3. After confirming the fit between the fuselage and bottom wing, use foam-safe CA to glue the bottom wing to the fuselage. Use a square between the fuselage and bottom wing to keep them in alignment while the CA fully cures.

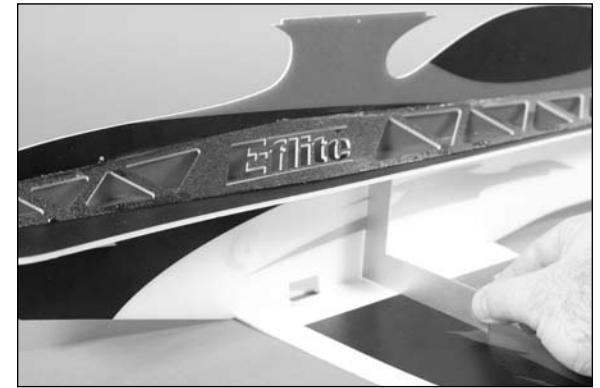

- 4. Locate the two outer struts. There is not a left or right strut, but you will want to match the trim scheme from right to left for aesthetics.

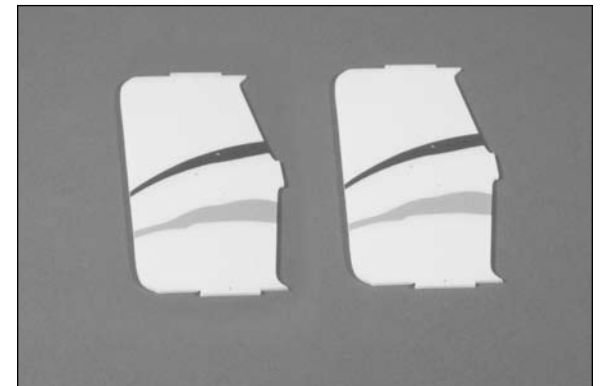

- 5. Test fit the outer strut into the bottom wing as shown. Make sure the tab is flat when inserted into the bottom wing. If not, you may induce an airfoil resulting in unwanted flight characteristics.



- 6. After confirming the fit between the outer strut and bottom wing, use foam-safe CA to glue the outer strut to the wing. Use a square between the outer strut and bottom wing to keep them in alignment while the CA fully cures.



- 7. Repeat Steps 5 and 6 to install the remaining outer strut. Make sure to match the trim scheme on the struts on each side or your flying buddies will laugh at you.

- 8. Locate the top wing. The bottom side of the top wing is white with no trim scheme.



- 9. Test fit the top wing to the fuselage and outer struts. The tab on the struts and fuselage will be flat in the top wing. If not, it may induce an unwanted airfoil that could result in unwanted flight characteristics.



- 10. Remove the top wing and place it upside down on your flat work surface. Use foam-safe CA to glue the top wing to the fuselage and outer struts. Make sure to use a square at both the struts and fuselage to keep things in alignment while the CA cures.

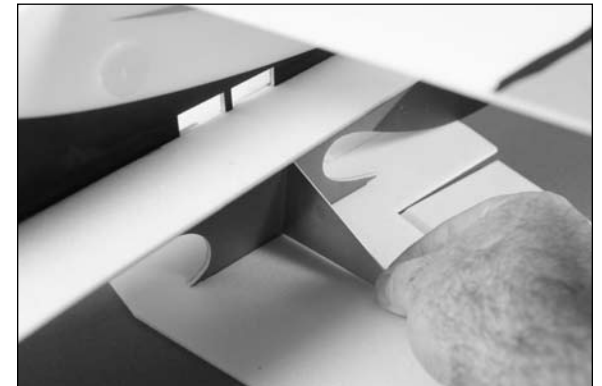
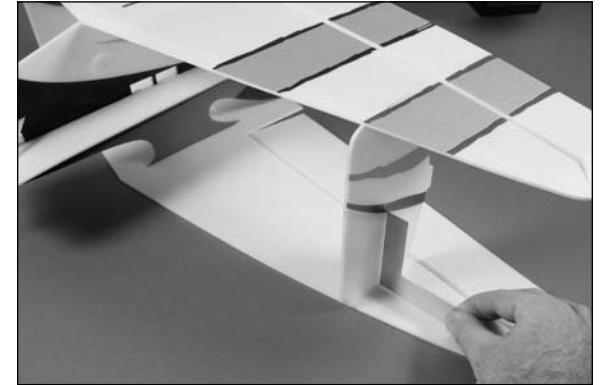

Carbon Bracing Installation

Required Parts

Airframe assembly

12³/₄ x 1/32-inch (325mm x 1mm) carbon rod,

Main wing bracing (4)

4¹/₈ x 1/32-inch (105mm x 1mm) carbon rod,

Outer strut to tip bracing (4)

5⁵/₁₆ x 1/32-inch (135mm x 1mm) carbon rod,

Top wing to fuselage bracing (2)

5³/₄ x 1/32-inch (145mm x 1mm) carbon rod,

Horizontal tail to fuselage bracing (2)

Required Tools and Adhesives

Square

Foam-safe CA

T-pin

E-tips

When installing the carbon rods, twisting them with your fingers while inserting them in the hole will help to smooth the exit and entry of the carbon rod.

- 1. Use the following images to position the four pieces of 12³/₄ x 1/32-inch (325mm x 1mm) carbon rod (two pieces on either side of the fuselage) that keep the top and bottom wings in alignment with the fuselage. Do not apply CA until instructed. The rod that runs from the top of the center cabane to the lower outer strut should be on the front of the cross.

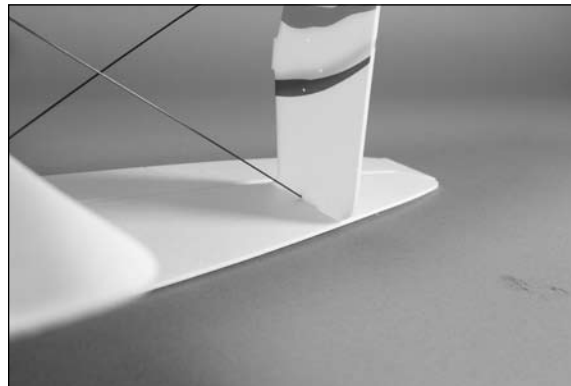

E-tips

When positioning the fuselage upside down on your work surface, the fin will need to hang off the edge of your work surface to keep the top wing perfectly flat.

- 2. With the top wing flat on your work surface, check that the struts and fuselage are square to the top and bottom wings. Apply a small amount of foam-safe CA at the points where the carbon rod are inserted in the top wing. The rod should be inserted completely through the wing but should not protrude past the top of the wing.

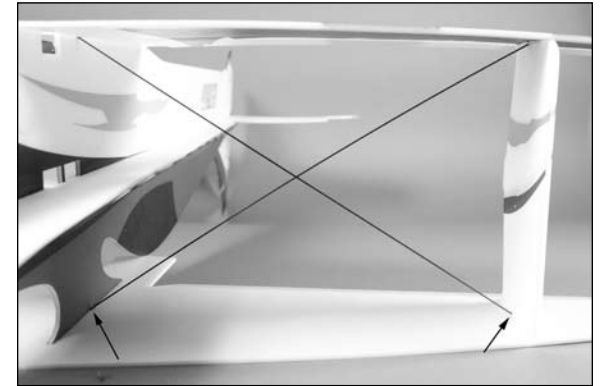

- 3. Make sure to keep the airframe very square while proceeding. Apply a few drops of foam-safe CA to the carbon rods where they enter the bottom wing. Also apply CA to the junction between the carbon rods where they cross each other. You can trim off any excess rod from the bottom of the wing after all four rods have been glued at each joint.

- 4. Using a square, install the $4\frac{1}{8} \times \frac{1}{32}$ -inch (105mm x 1mm) carbon rods between the left and right outer struts and bottom wing as shown. Make sure to keep the bottom wing flat on your work surface and not to deflect the outer struts between the top and bottom wings when installing the carbon rods.

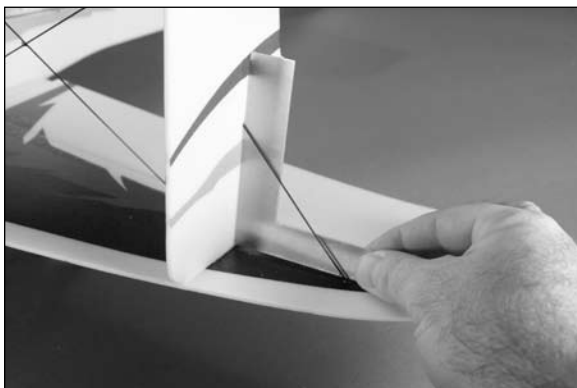

- 5. Install the remaining $4\frac{1}{8} \times \frac{1}{32}$ -inch (105mm x 1mm) carbon rods between the left and right outer struts and top wing as shown. Make sure to keep the top wing flat and not to deflect the outer struts between the top and bottom wings when installing the carbon rods.

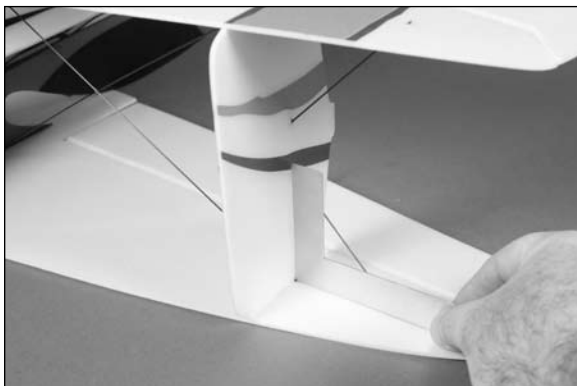

- 6. Use foam-safe CA to install the two $5\frac{5}{16} \times \frac{1}{32}$ -inch (135mm x 1mm) carbon rods between the top wing and fuselage as shown. Use care not to induce any warps in the top wing while installing the braces.

Etips

These two (2) rods affect the wing in many different ways. Use caution to make sure that the wing stays flat and is also still perpendicular to the fuselage.



- 7. Check the alignment between the wings and stabilizer. Position the stabilizer so it is parallel to both the top and bottom wings as shown. It should also be square to the fuselage. Check to make sure that the wing and stabilizer are also perpendicular to the fuselage.

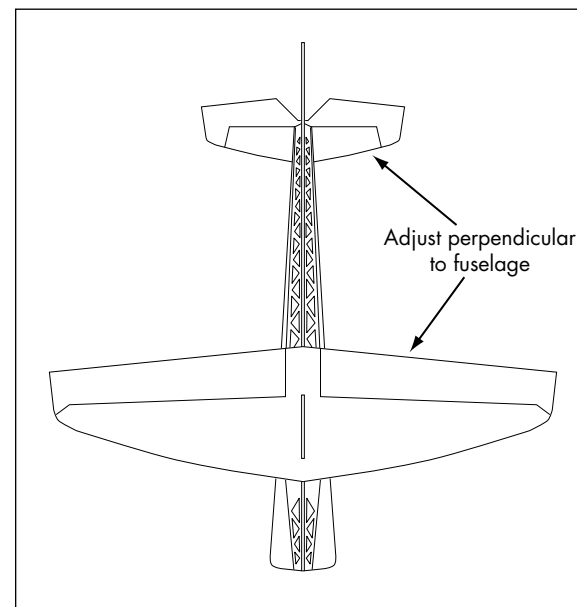
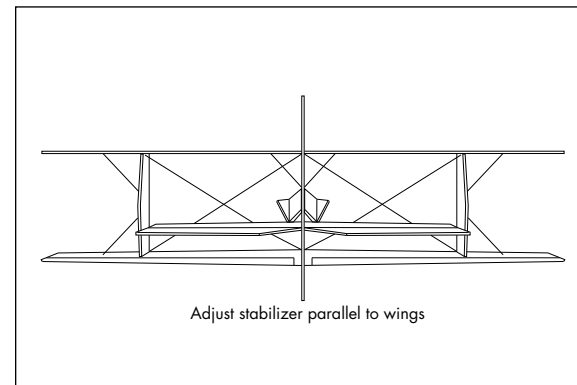

- 8. While keeping the stabilizer in alignment, apply foam-safe CA to the left and right horizontal fuselage as well as the left and right diagonal braces to secure them to the fuselage and stabilizer.

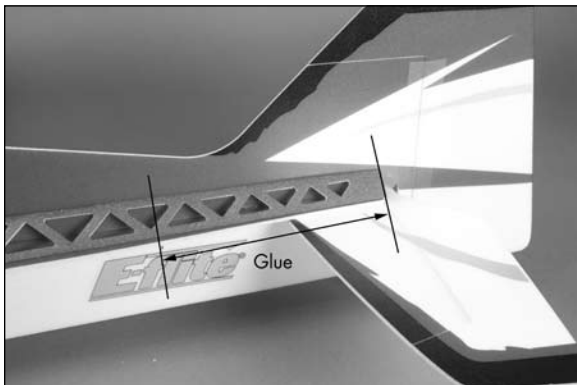

- 9. Use a T-pin to poke a hole through the hinge tape at the hole where the carbon bracing for the stabilizer will go through.

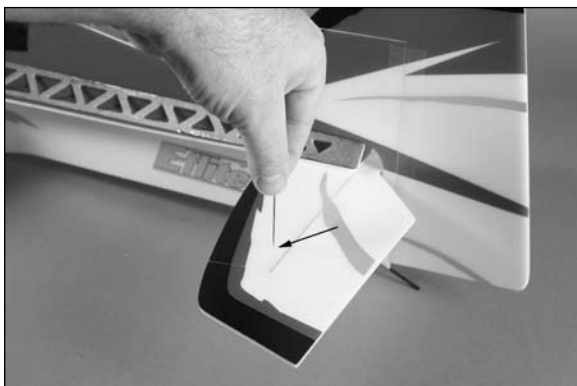

- 10. Use foam-safe CA to install the two $5\frac{3}{4} \times 1\frac{1}{32}$ -inch (145mm x 1mm) carbon rods that brace the stabilizer. Use the drawing from Step 8 as a guide for positioning the stabilizer. It must be parallel to the top and bottom wings, as well as straight across and flat as shown. You can also use a square to help with this alignment.

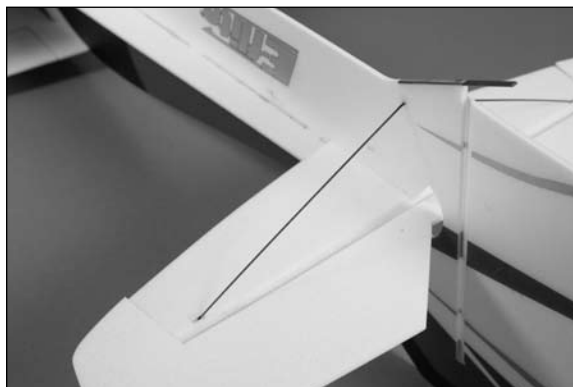

Landing Gear Installation

Required Parts

Assembled airframe
 $6\frac{7}{8} \times 3\frac{3}{32}$ -inch (175mm x 2.5mm) carbon rod,
 Main landing gear (2)
 Landing gear support
 Wheel skid (2)

Required Tools and Adhesives

Sandpaper Foam-safe CA
 Thin CA

- 1. Use foam-safe CA to glue the landing gear support to the bottom of the bottom wing. Make sure the support is aligned with the leading edge of the wing and the center points are aligned.

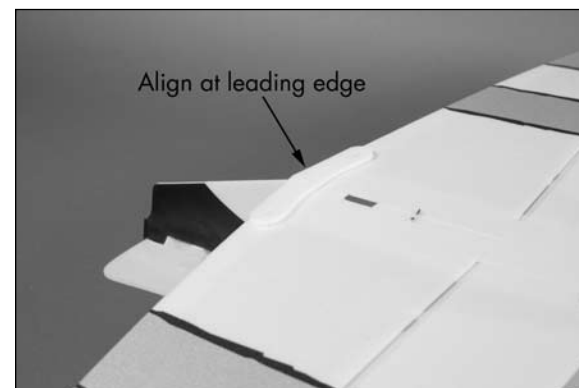

- 2. Use medium grit sandpaper to sand an angle on one end of each of the two $6\frac{7}{8} \times 3/32$ -inch (175mm x 2.5mm) carbon rods. This angle should be around 45-degrees and will allow the carbon rods to fit against each other to provide a much stronger landing gear assembly.

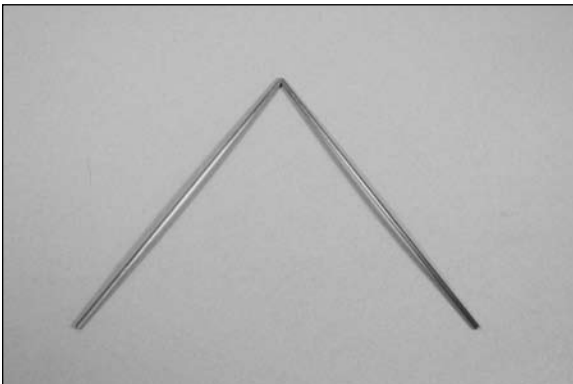
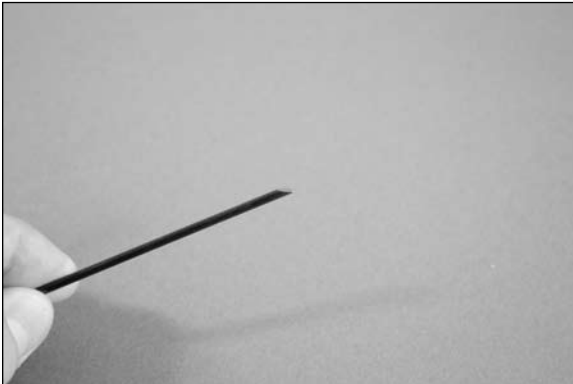
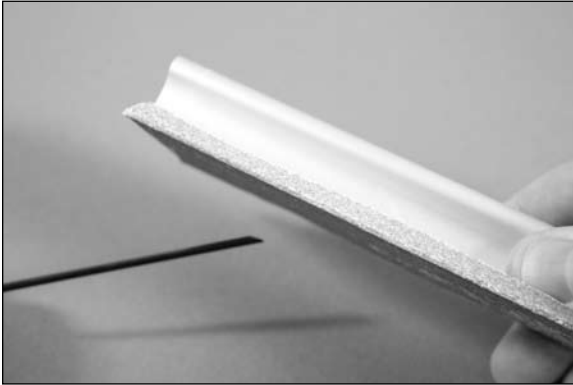

- 3. Test fit the two carbon rods in the aircraft as shown. Once the fit is acceptable, and the airframe will sit level, use foam-safe CA to glue the carbon rods into position. Allow the CA to fully cure before proceeding.



- 4. Test the fit of the two wheel skids on the ends of the carbon rods. The skids will be parallel to the fuselage when installed correctly. Use thin CA to glue the skids to the carbon rods.

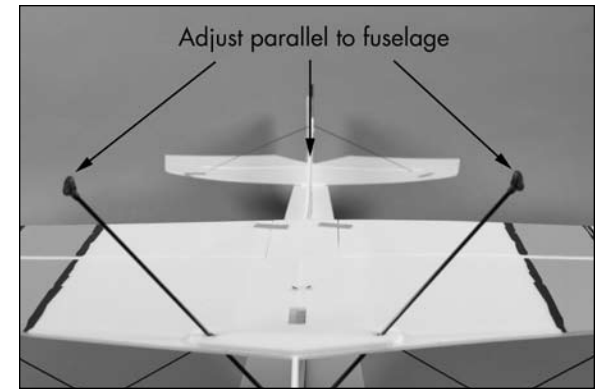

Motor Installation

Required Parts

Assembled airframe Carbon firewall
Motor Receiver
Transmitter Motor battery
Speed control
Right lower diagonal brace

Required Tools and Adhesives

Foam-safe CA Sandpaper
Flat blade screwdriver, small
Phillips screwdriver, #1
Hobby knife with #11 blade or round file

- 1. Locate the carbon firewall. There are four holes in the firewall: two large and two small. The two smaller holes are the alignment points for positioning the firewall on the fuselage. These holes will be located just like the ones on the Depron firewall.

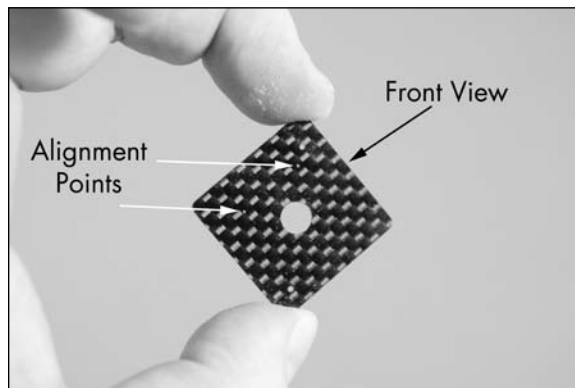

- 2. Use medium grit sandpaper to lightly sand the back side of the firewall. The glue will be applied to this side of the firewall to attach it to the fuselage.

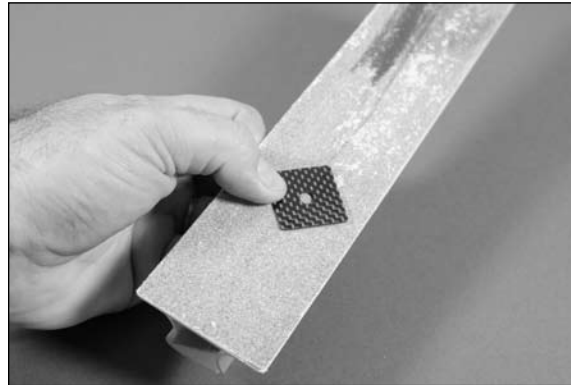

- 3. Match the two alignment points to those in the Depron firewall (top and left as viewed from the front of the fuselage). Use foam-safe CA to secure the firewall to the fuselage.

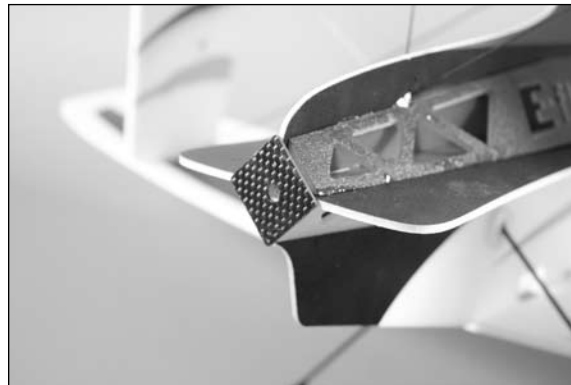

- 4. It may be necessary to remove a small amount of material from behind the firewall to clear the motor shaft of your particular motor. You can use either a round file or hobby knife to accomplish this task.

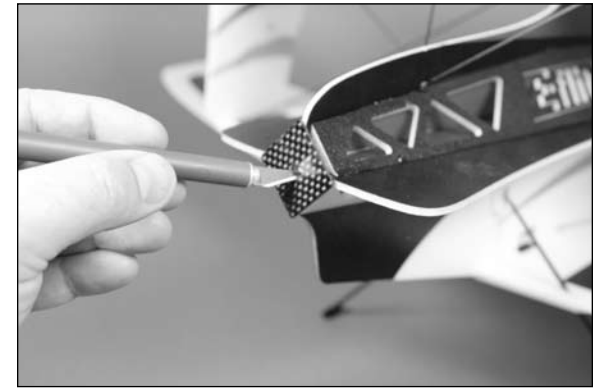

- 5. Attach the motor mount to the motor following the instructions provided with the motor using a flat blade screwdriver. Note the position of the motor wires in relation to the motor, as they need to be positioned as such to connect to the speed control.

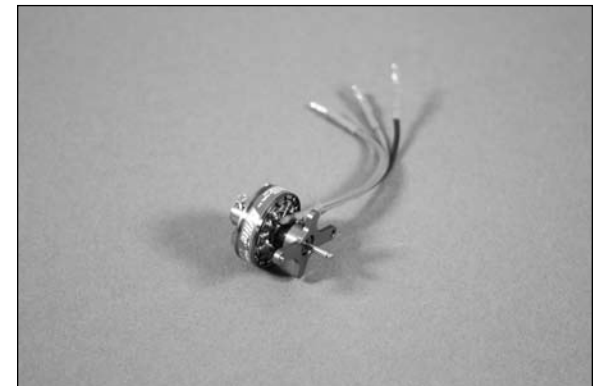

- 6. Use a #1 Phillips screwdriver and the two screws provided with your motor to attach it to the firewall. Work slowly to avoid applying too much pressure, resulting in damage to your airframe.

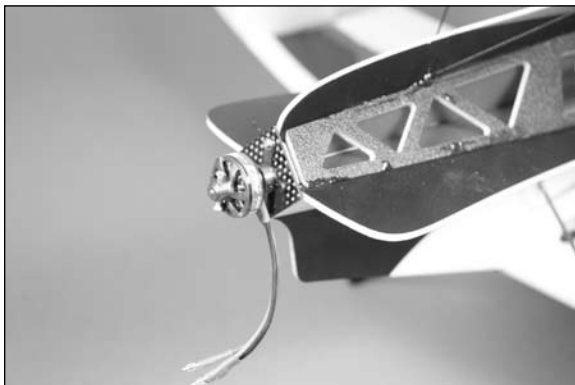

- 7. Pass the motor wires through the slot in the front of the fuselage. Connect the wires from the motor to those of the speed control. The battery lead from the speed control can now be passed to the opposite side of the fuselage through the slot in the fuselage as well.



- 8. Check the operation of the motor at this time. It should rotate counterclockwise when viewed from the front of the aircraft. If not, follow the instructions provided with your speed control to correct the situation.

E-tips

Never check the motor rotation on the bench with the propeller installed. The plane could move and cause serious injury. Always check the motor without the propeller to avoid injury.

- 9. Use foam-safe CA to glue the right lower diagonal brace on the fuselage.



- 10. The speed control should be positioned between the two braces as shown.

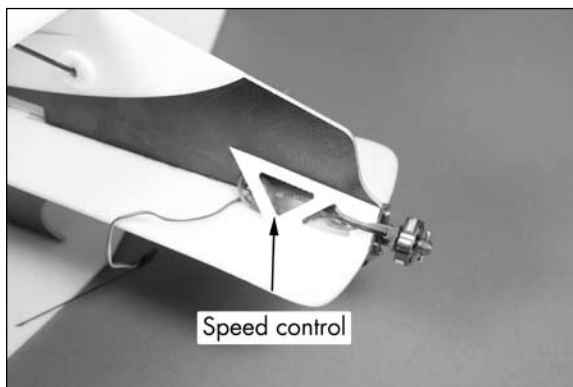

Control Horn Installation

Required Parts

Assembled airframe Depron control horn support (4)
13/16 x 1/16-inch (20mm x 1mm) carbon rod, control rod (4)

Required Tools and Adhesives

Foam-safe CA Hobby knife
Felt-tipped pen Low-tack tape
Ruler T-pin

- 1. Use a ruler and felt-tipped pen to measure and mark the four 13/16 x 1/16-inch (20mm x 1mm) carbon rods 19/32-inch (15mm) from the end of each rod.

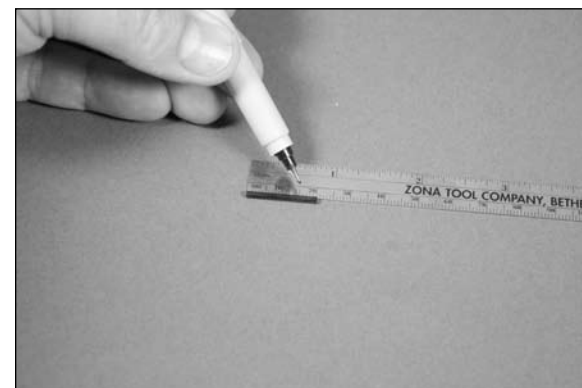

- 2. Use foam-safe CA to glue a carbon rod to the control horn support as shown. Assemble four control horns at this time.

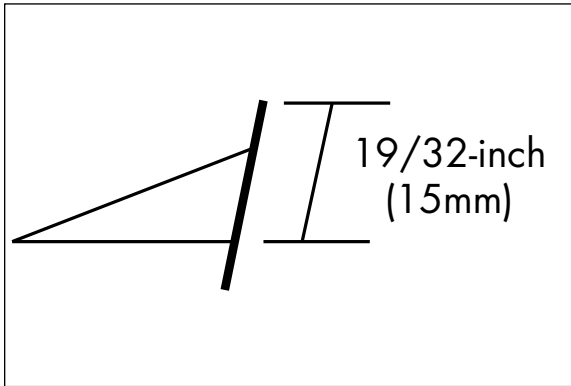

E-tips

Cut small pieces of low-tack tape and use them to keep the control surfaces stationary while installing the control horns and linkages. Make sure not to apply tape to any colored surfaces as it will damage the trim scheme.

- 3. Use a T-pin to poke a hole in the hinge tape for each of the bottom ailerons, rudder and elevator.

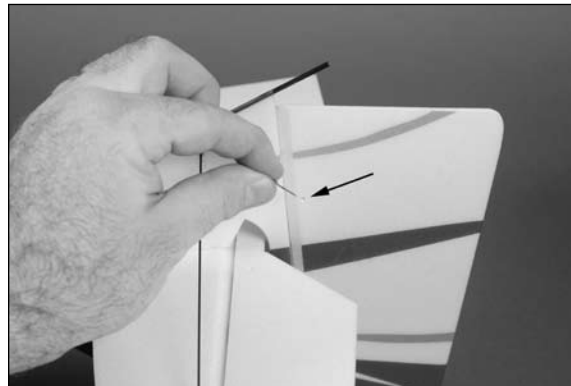
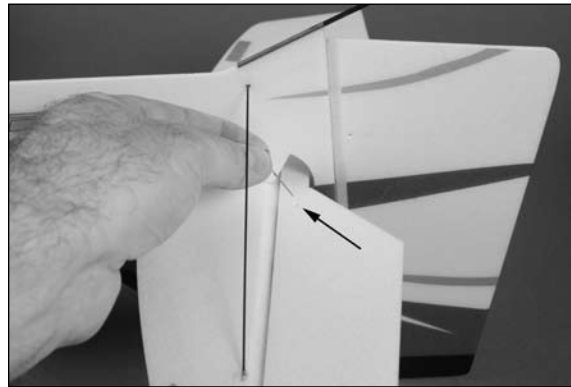
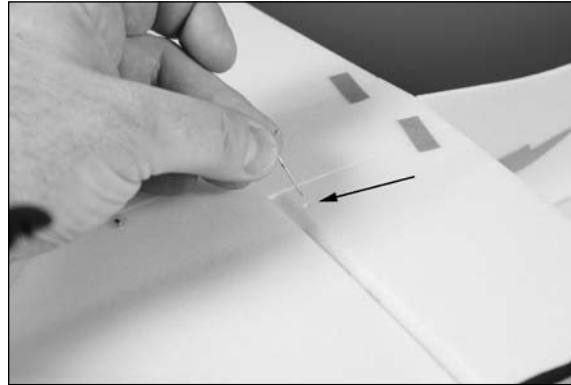

- 4. Use foam-safe CA to glue the control horns in position. Make sure the control horn supports are perpendicular to the hinge line on each of the control surfaces.

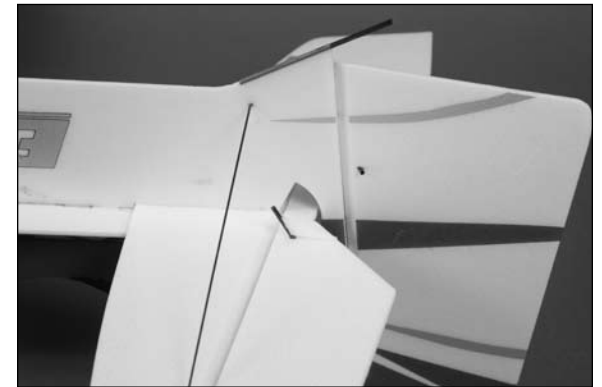
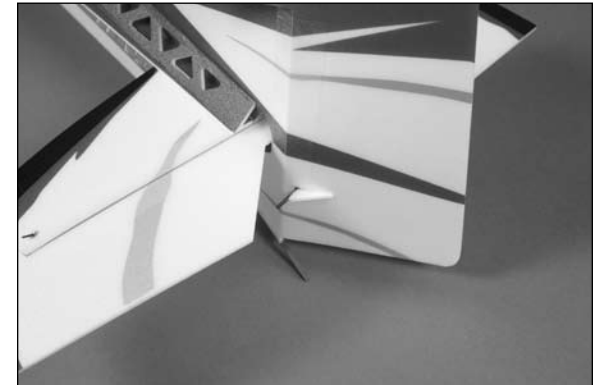
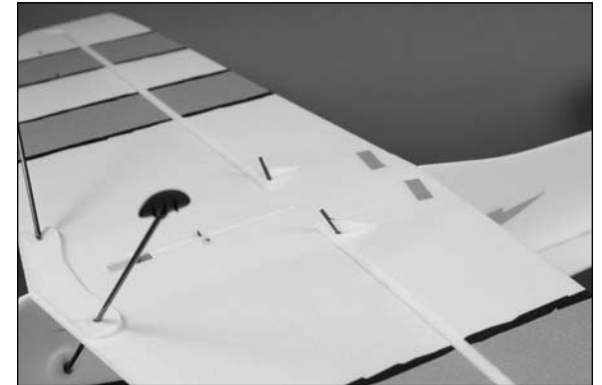

Radio and Linkage Installation

Required Parts

Assembled airframe	Transmitter
Receiver	Heat shrink (8)
Servo (3)	Receiver
3D Servo arm (3)	Hook and loop tape
23 ⁵ / ₈ -inch (600mm) rudder and elevator carbon pushrod (2)	
3 ¹ / ₂ -inch (90mm) aileron carbon pushrod (2)	
6 ⁷ / ₈ -inch (175mm) aileron link carbon rod (2)	
1 x 3/32-inch (25mm x 2mm) carbon rod, aileron control horn (4)	

Required Tools and Adhesives

Foam-safe CA	Phillips screwdriver, #0
Soldering iron	Clear tape
Side cutters	Low-temperature glue gun

- 1. Plug the rudder, elevator and aileron servos into their corresponding ports of the receiver. Starting with a new model, turn on the radio to center the servos. Use a #0 Phillips screwdriver to remove the original arms from the servos and install the long 3D arms.

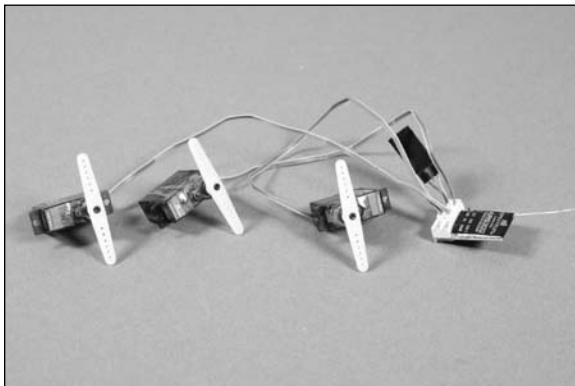

E-tips

There are more ways to lighten the 4-Site. Some of these options will void the warranty for the products used. These steps are covered in the E-flite Enticement manual which can be found on the Enticement product page at www.horizonhobby.com.

- 2. Prepare the rudder servo by removing the unused arm from the servo horn as shown.

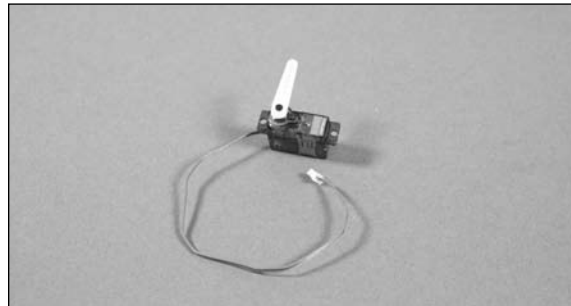

- 3. Test fit the rudder servo in the rear hole in the main fuselage. The output of the servo will face the tail of the aircraft. Once fit, use a low-temperature glue gun or foam-safe CA to adhere the servo to the fuselage.

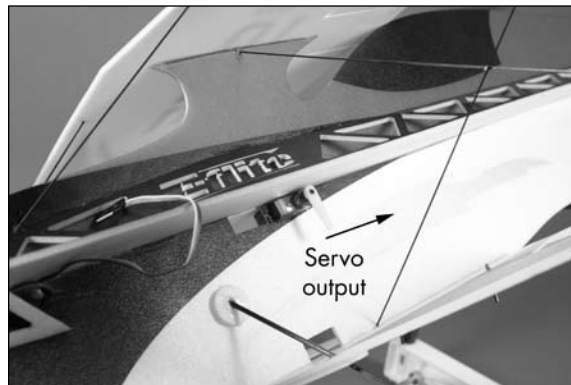

- 4. Prepare the elevator servo by removing the unused arm from the servo horn as shown.

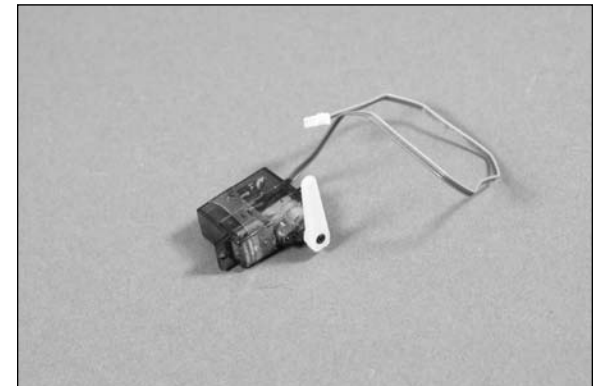

- 5. Test fit the elevator servo in the remaining hole in the main fuselage. The output of the servo will face the tail of the aircraft. Once fit, use a low-temperature glue gun or foam-safe CA to adhere the servo to the fuselage.

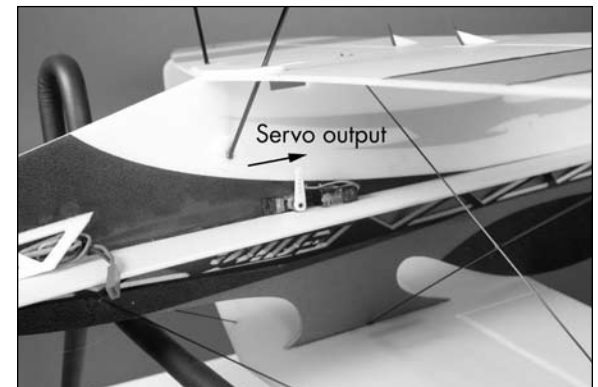

- 6. Test fit the aileron servo in the hole in the bottom of the bottom wing. The output of the servo will face the tail of the aircraft. Once fit, use a low-temperature glue gun or foam-safe CA to adhere the servo to the wing.

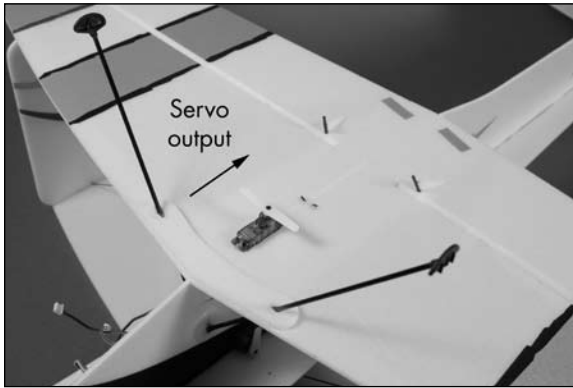

- 7. Plug the servos into the receiver at this time. You may need to plug an adapter in the receiver to connect the lead from the speed control as well. Use hook and loop tape to secure the receiver to the fuselage.



E-tips

Use clear tape to neatly organize the servo leads.

E-tips

It is possible for the ends of the pushrods to come loose in packaging and shipping. It is a good practice to check these ends. If they are loose, reglue the ends by placing a drop of foam-safe CA at each end of the heat shrink.

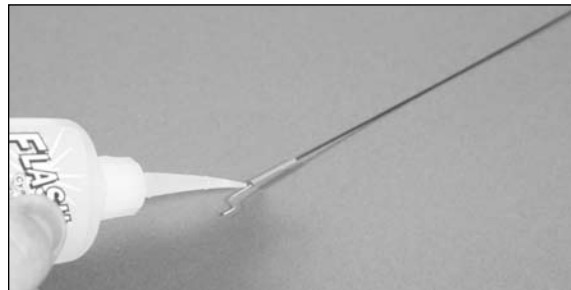
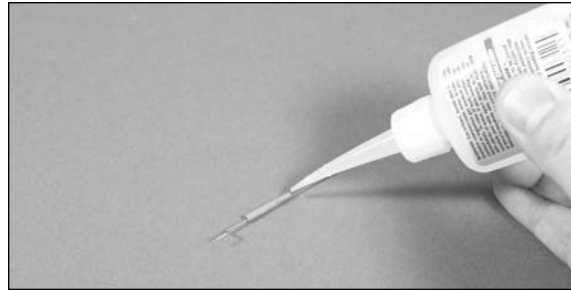

- 8. Insert the bend of the 23⁵/₈-inch (600mm) rudder pushrod into the servo arm. Use the third hole in from the end of the servo arm as shown.

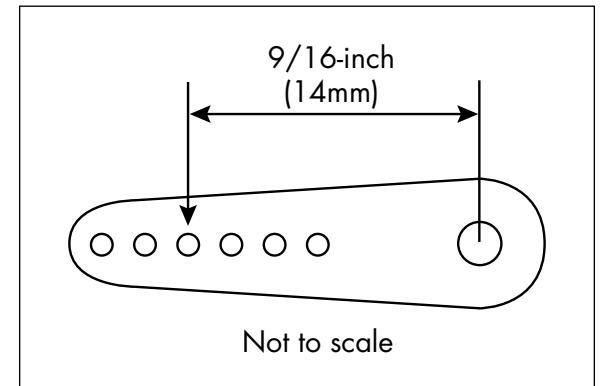

E-tips

It might be easier to insert the pushrod if you remove the horn from the servo. If this is done, just make sure that you center it when placing it back on the servo.

- 9. Locate three of the pushrod supports and slide the supports onto the pushrod as shown in the second photo.

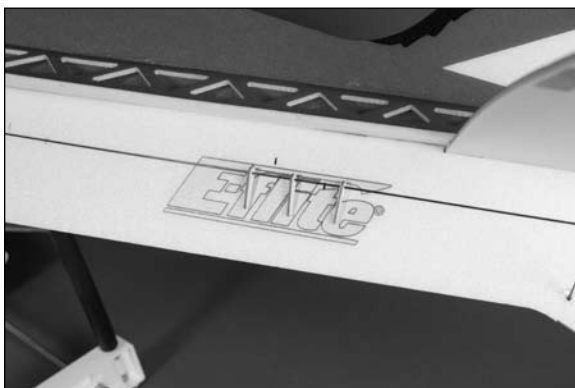
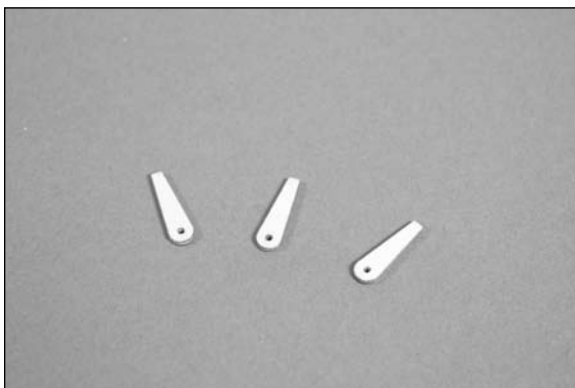

- 10. Insert the pushrod guides into the slots in the fuselage. In each position, there is a pair of holes. The rudder pushrod supports go in the rear hole of each pair. Do not glue the supports yet.



- 11. Align the pushrod with the rudder control horn.

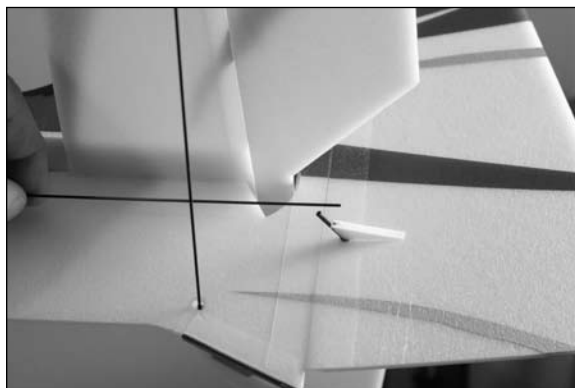

- 12. The pushrod is supplied slightly long to accommodate for servo selection and control horn position. Use side cutters to trim the pushrod so it almost touches the rudder control horn.

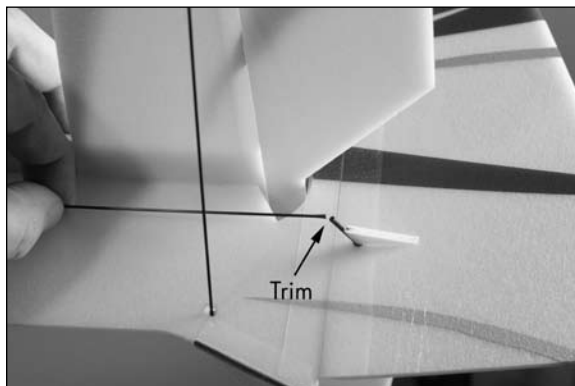

- 13. Slide a piece of heat shrink on the pushrod and control horn.

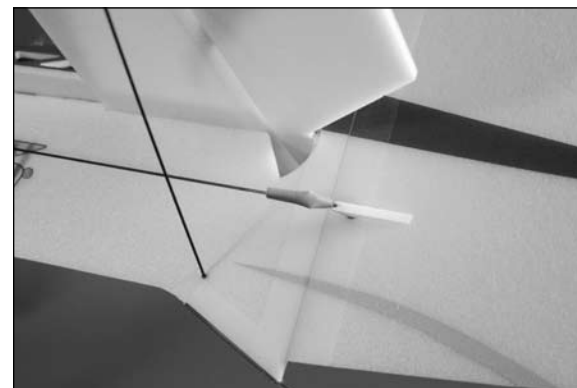

E-tips

Only use a soldering iron to shrink the tubing for the control rods. A heat gun or lighter will damage the control surfaces. Use care not to touch the soldering iron to any of the control surfaces.

E-tips

You will notice that there is extra heat shrink supplied with the kit. This is in case you lose one or need to redo a linkage.

- 14. Use a soldering iron to shrink the tubing to secure the pushrod to the control horn.

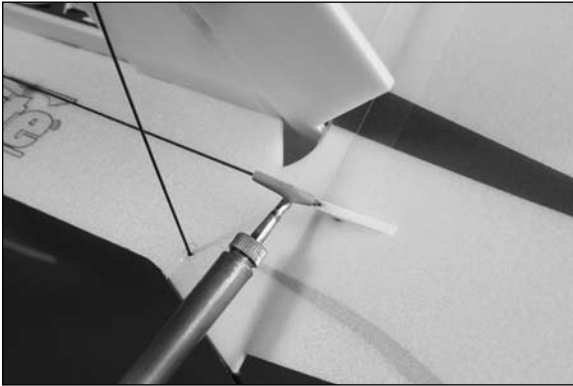
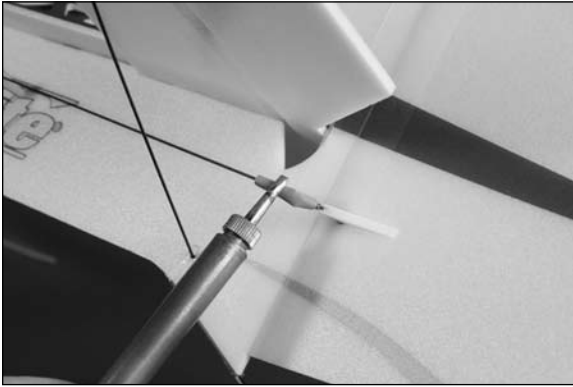

- 15. Go back and align the supports so that the pushrod is straight, and glue them in using foam-safe CA.

- 16. Insert the bend of the 23 ⁵/₈-inch (600mm) elevator pushrod into the servo arm. Use the second hole in from the end of the servo arm as shown.

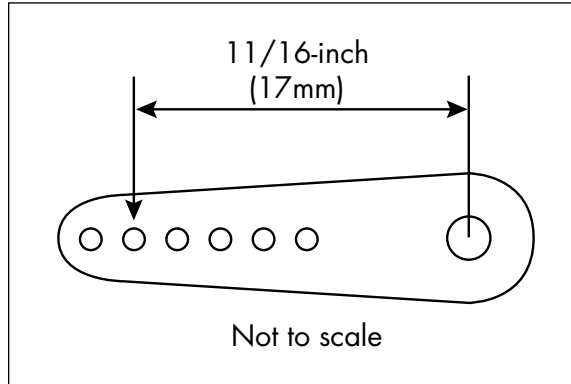

- 17. Insert the pushrod guides into the slots in the fuselage. In each position, there is a pair of holes. The elevator pushrod supports will be flush with the opposite side of the fuselage when installed. Do not glue the supports at this time.

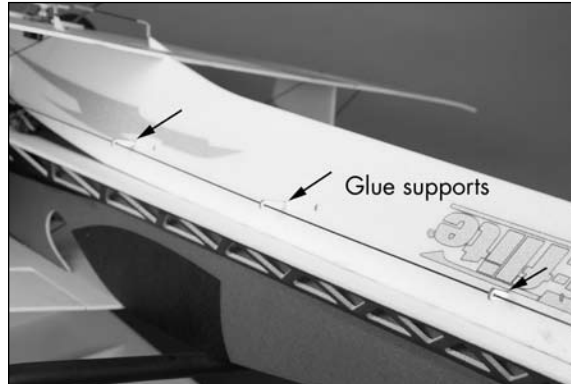

- 18. After aligning and trimming the elevator pushrod using side cutters, connect the pushrod to the elevator control horn using heat shrink tubing and a soldering iron.

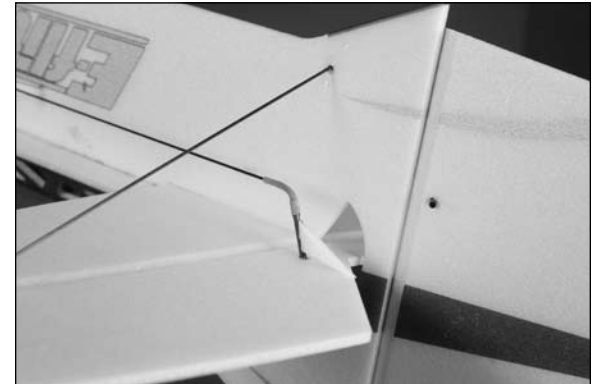

- 19. Go back and align the supports so that the pushrod is straight and glue them in using foam-safe CA.
- 20. The installation of the aileron pushrod follows the same procedure as the elevator and rudder pushrods, only without the supports.

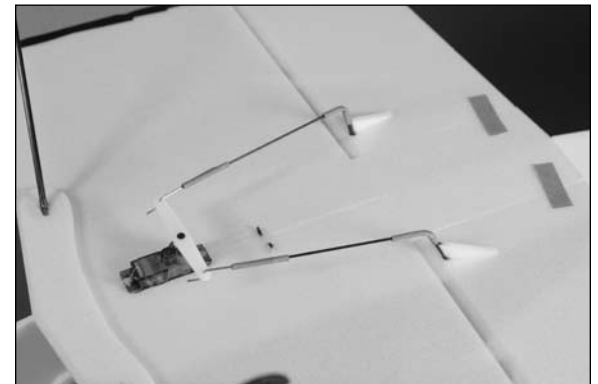
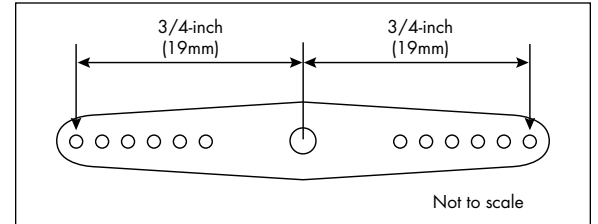

- 21. Once the pushrods are connected to the control horns, apply a drop of foam-safe CA to the heat shrink tubing. Apply CA to both the pushrod and control horn side to secure the tubing to each.

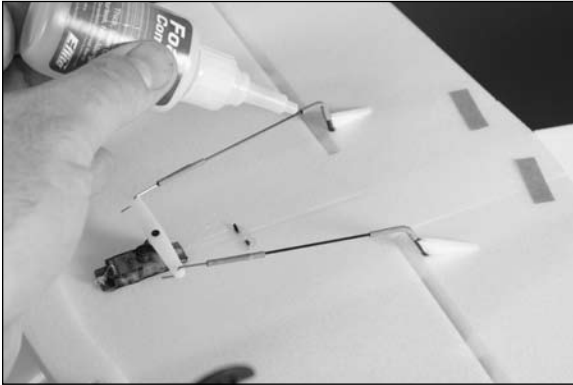

- 22. Use foam-safe CA to glue the two 1 x 3/32-inch (2 x 25mm) carbon rods in the slots in the top and bottom ailerons. Make sure the rods are parallel and centered with the ailerons when installed.

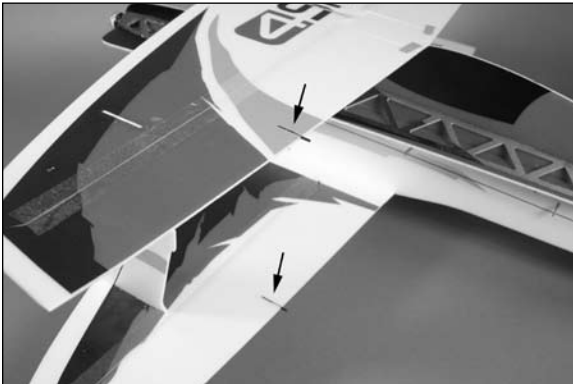

- 23. Connect the 6 7/8-inch (175mm) carbon rod to the control horn of the upper aileron using a piece of heat shrink and a soldering iron.



- 24. Use side cutters to trim the carbon rod to the proper length. Use a piece of heat shrink and a soldering iron to make the connection between the top and bottom ailerons.



- 25. Apply a drop of foam-safe A to the heat shrink at both the top and bottom ailerons. Make sure to apply CA to both the pushrod and control horn.

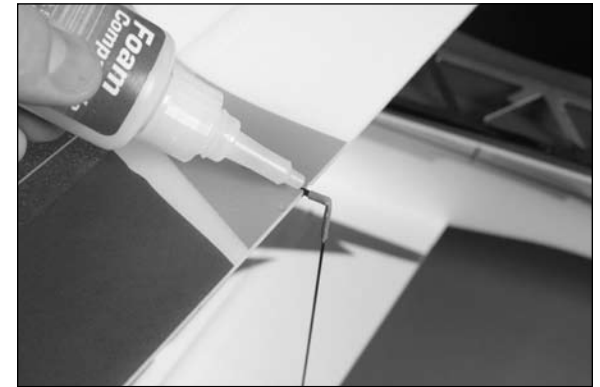

- 26. Repeat Steps 22 through 25 to connect the remaining top and bottom aileron.
- 27. Remove the tape used to keep the control surfaces centered at this time.

Final Assembly

Required Parts

Assembled airframe	Propeller
Propeller adapter	Wheel pant (2)
Motor battery	Hook and loop tape

Required Tools and Adhesives

Foam-safe CA

Etips

Important Information About Your Propeller

It is very important to check to be sure the propeller is balanced before installing onto the shaft. An unbalanced propeller may strip the gears or cause poor flight characteristics.

If it is necessary to enlarge the hole in the propeller or the spinner, make sure to check the balance of each afterwards.

- 1. Locate the propeller adapter (included with motor) that fits your particular model. Insert the adapter in the propeller, making sure it is installed in the backside of the propeller.



- 2. Mount the propeller following the instructions provided with your motor.



- 3. Foam-safe CA is used to glue the wheel pants to the wheel skids. A small notch in the wheel pant will align with the center ridge on the wheel skid. Make sure there is clearance between your work surface and the wheel pants so they do not rub during take-off or landing.



- 4. Use scissors to cut a 25mm piece of hook and loop tape. Peel the backing from the softer side and attach it to the battery.

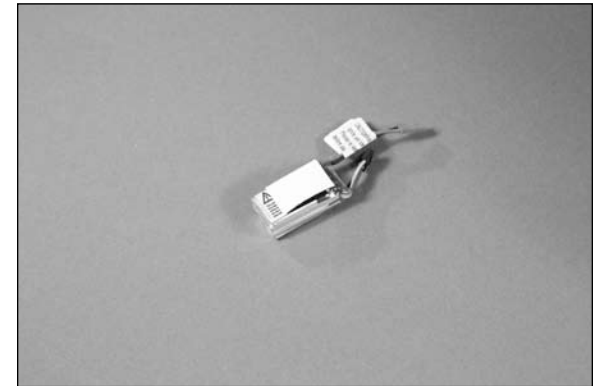

- 5. The battery attaches roughly 25mm in front of the elevator servo. The exact position can be adjusted to correct the Center of Gravity if it is not correct according to this manual.

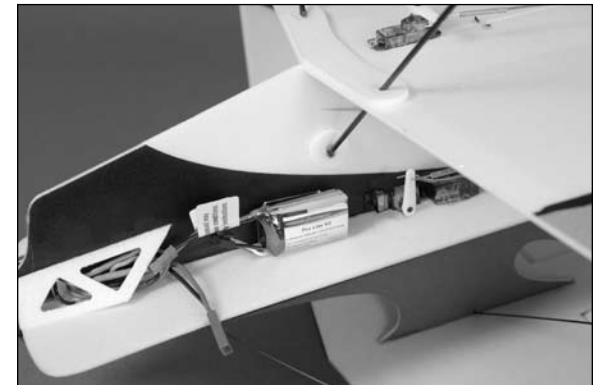

Air Brake Assembly (Optional)

Required Parts

Assembled airframe

3³/₈-inch (80mm) air brake support carbon rod (4)

Air brake, large (2)

Air brake, small (2)

Required Tools and Adhesives

Square

Foam-safe CA

- 1. Locate the large and small air brakes. The air brakes are an optional part. There are two different size air brakes supplied with the 4-Site. If you are interested in flying more aggressive 3D style maneuvers you may want to leave these off. If you fly mainly in a large indoor facility, then you will want to use the smaller air brakes. If you fly in a smaller area like a one court size gym, then the larger air brakes will slow the 4-Site down more. You may choose to try all three variations. Do this by just lightly tack gluing the air brakes on at first. Choose the set of air brakes that suits your particular flying location and flying style.

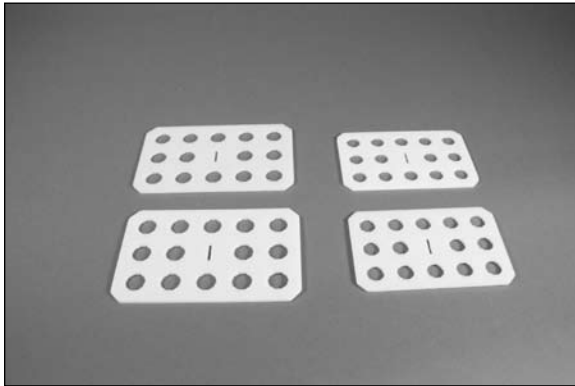

- 2. Use foam-safe CA to glue the air brake to the outer strut. Use a square to align the air brake with the outer strut as shown.

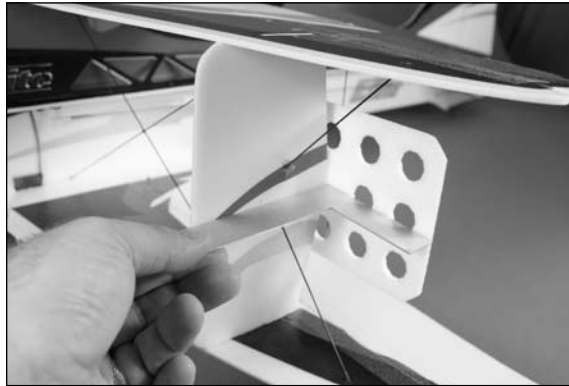

- 3. Use two 3³/₈-inch (80mm) carbon rods to support the air brake and keep it from changing angle. The carbon rods are glued using foam-safe CA. Use a square to check that the air brake is still square to the outer strut before the CA fully cures.

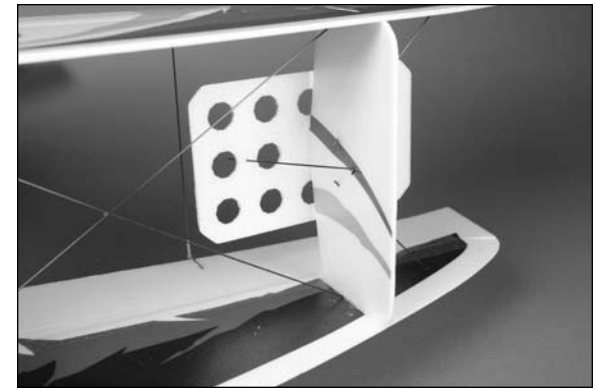

- 4. Repeat Steps 2 and 3 to install the remaining matching air brake.

Control Throws

- 1. Turn on the transmitter and receiver of your model. Check the movement of the rudder using the transmitter. When the stick is moved right, the rudder should also move right. Reverse the direction of the servo at the transmitter if necessary.
- 2. Check the movement of the elevator with the radio system. Moving the elevator stick toward the bottom of the transmitter will make the airplane elevator move up.
- 3. Check the movement of the ailerons with the radio system. Moving the aileron stick right will make the right aileron move up and the left aileron move down.
- 4. Use a ruler to adjust the throw of the elevator, ailerons and rudder.

Aileron High Rate

Up	2 ¹ / ₈ -inch	(55mm)
Down	2 ¹ / ₈ -inch	(55mm)

Aileron Low Rate

Up	1 ³ / ₁₆ -inch	(30mm)
Down	1 ³ / ₁₆ -inch	(30mm)

Elevator High Rate

Up	1 ³ / ₄ -inch	(45mm)
Down	1 ³ / ₄ -inch	(45mm)

Elevator Low Rate

Up	1 ³ / ₁₆ -inch	(30mm)
Down	1 ³ / ₁₆ -inch	(30mm)

Rudder High Rate

Up	3 ¹ / ₈ -inch	(80mm)
Down	3 ¹ / ₈ -inch	(80mm)

Rudder Low Rate

Up	2-inch	(50mm)
Down	2-inch	(50mm)

You will notice that when you get to the full travel of high rates on the aileron servo you will see a slight difference in the travel amount from top to bottom due to the servo linkage offset. This does not affect the flight performance of the 4-Site.

E-tips

Measurements are taken at the inner or widest point on the control surface.

These are general guidelines measured from our own flight tests. You can experiment with higher rates to match your preferred style of flying.

E-tips

Travel Adjust, Sub Trim and Dual Rates are not listed and should be adjusted according to each individual model and preference.

Center of Gravity

An important part of preparing the aircraft for flight is properly balancing the model.

Caution: Do not inadvertently skip this step!

The recommended Center of Gravity (CG) location for your model is 2⁷/₈ to 3⁹/₁₆ inches (75–90mm) back from the leading edge of the top wing at the center. Make sure to measure from the farthest point forward for accuracy. Mark the location for the Center of Gravity on the bottom of the top wing next to the fuselage as shown.

Adjust components as necessary so the model hangs level or slightly nose down. This is the correct balance point for your model. You might find that you need to shift the battery slightly to either the front or back of the fuselage to achieve the correct balance.

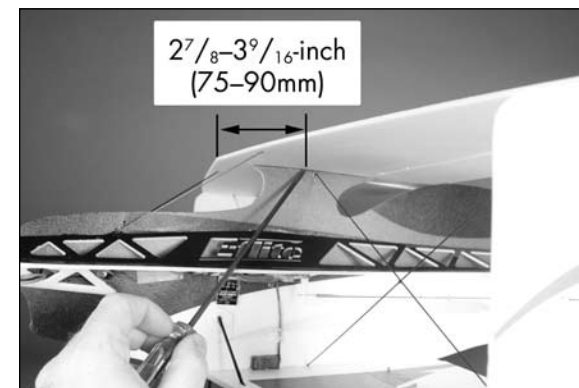

After the first flights, the CG position can be adjusted for your personal preference.

E-tips

You can use a small ball driver or pen to hold the 4-Site up during balancing.

Preflight

Check Your Radio

Before going to the field, be sure that your batteries are fully charged per the instructions included with your radio. Charge both the transmitter and receiver pack for your airplane. Use the recommended charger supplied with your particular radio system, following the instructions provided with the radio. In most cases, the radio should be charged the night before going out flying.

Before each flying session, be sure to range check your radio. See your radio manual for the recommended range and instructions for your radio system. Each radio manufacturer specifies different procedures for their radio systems. Next, start the motor. With the model securely anchored, check the range again. The range test should not be significantly affected. If it is, don't attempt to fly! Have your radio equipment checked out by the manufacturer.

Note: Keep loose items that can get entangled in the propeller away from the prop. These include loose clothing, or other objects such as pencils and screwdrivers. Especially keep your hands away from the propeller.

Double-check that all controls (aileron, elevator, rudder and throttle) move in the correct direction.

Check the radio installation and make sure all the control surfaces are moving correctly (i.e. the correct direction and with the recommended throws). Test run the motor and make sure it transitions smoothly from off to full throttle and back. Also ensure the engine is installed according to the manufacturer's instructions, and it will operate consistently.

Check all the control horns, servo horns, and clevises to make sure they are secure and in good condition. Repair or replace any items that would be considered questionable. Failure of any of these components in flight would mean the loss of your aircraft.

Range Test Your Radio

- 1. Before each flying session, be sure to range check your radio. This is accomplished by turning on your transmitter with the antenna collapsed. Turn on the receiver in your airplane. With your airplane on the ground and the engine running, you should be able to walk 30 paces (approximately 100 feet) away from your airplane and still have complete control of all functions.

If not, don't attempt to fly! Have your radio equipment checked out by the manufacturer.

- 2. Double-check that all controls (aileron, elevator, rudder and throttle) move in the correct direction.
- 3. Be sure that your transmitter batteries are fully charged, per the instructions included with your radio.

Flying Your 4-Site

Flying the 4-Site is about as fun as it can get. Very light wing loading and extreme control throws make for some precise F3P flying. Verify that your CG is at the correct location as per the manual and that you have your rates set up to your liking.

Verify all control throws are in the correct direction and the motor spins in the correct direction as well. Point the model into the wind and add some throttle trim until the motor begins to turn. This will be your flight idle. We recommend hand launching the model if you are flying from of a rough surface.

Apply power slowly. You will find the model will become airborne very quickly and at a low speed. This model excels at flying slow and easy. Trim the model for level flight at half throttle. Only use full throttle for maneuvering.

You will find you can adjust the CG to your liking by moving the battery pack fore or aft on the fuselage.

To land the 4-Site just reduce the throttle to idle and feed in up elevator until the model settles into a slightly nose-high attitude.

Gently fly the model down to the landing spot with a final flair at touchdown.

We hope you enjoy the 4-Site as much as we do.

Happy landings.

Safety Do's and Don'ts for Pilots

- Check all control surfaces prior to each takeoff.
- Do not fly your model near spectators, parking areas or any other area that could result in injury to people or damage of property.
- Do not fly during adverse weather conditions. Poor visibility can cause disorientation and loss of control of your aircraft. Strong winds can cause similar problems.
- Do not take chances. If at any time during flight you observe any erratic or abnormal operation, land immediately and do not resume flight until the cause of the problem has been ascertained and corrected. Safety can never be taken lightly.
- Do not fly near power lines.

Safety Precautions

This is a sophisticated hobby Product and not a toy. It must be operated with caution and common sense and requires some basic mechanical ability. Failure to operate this Product in a safe and responsible manner could result in injury or damage to the Product or other property. This Product is not intended for use by children without direct adult supervision. The Product manual contains instructions for safety, operation and maintenance. It is essential to read and follow all the instructions and warnings in the manual, prior to assembly, setup or use, in order to operate correctly and avoid damage or injury.

Warranty Information

WARRANTY PERIOD

Exclusive Warranty- Horizon Hobby, Inc., (Horizon) warranties that the Products purchased (the "Product") will be free from defects in materials and workmanship at the date of purchase by the Purchaser.

LIMITED WARRANTY

(a) This warranty is limited to the original Purchaser ("Purchaser") and is not transferable. REPAIR OR REPLACEMENT AS PROVIDED UNDER THIS WARRANTY IS THE EXCLUSIVE REMEDY OF THE PURCHASER. This warranty covers only those Products purchased from an authorized Horizon dealer. Third party transactions are not covered by this warranty. Proof of purchase is required for warranty claims. Further, Horizon reserves the right to change or modify this warranty without notice and disclaims all other warranties, express or implied.

(b) Limitations- HORIZON MAKES NO WARRANTY OR REPRESENTATION, EXPRESS OR IMPLIED, ABOUT NON-INFRINGEMENT, MERCHANTABILITY OR FITNESS FOR A PARTICULAR PURPOSE OF THE PRODUCT. THE PURCHASER ACKNOWLEDGES THAT THEY ALONE HAVE DETERMINED THAT THE PRODUCT WILL SUITABLY MEET THE REQUIREMENTS OF THE PURCHASER'S INTENDED USE.

(c) Purchaser Remedy- Horizon's sole obligation hereunder shall be that Horizon will, at its option, (i) repair or (ii) replace, any Product determined by Horizon to be defective. In the event of a defect, these are the Purchaser's exclusive remedies. Horizon reserves the right to inspect any and all equipment involved in a warranty claim. Repair or replacement decisions are at the sole discretion of Horizon. This warranty does not cover cosmetic damage or damage due to acts of God, accident, misuse, abuse, negligence, commercial use, or modification of or to any part of the Product. This warranty does not cover damage due to improper installation, operation, maintenance, or attempted repair by anyone other than Horizon. Return of any goods by Purchaser must be approved in writing by Horizon before shipment.

DAMAGE LIMITS

HORIZON SHALL NOT BE LIABLE FOR SPECIAL, INDIRECT OR CONSEQUENTIAL DAMAGES, LOSS OF PROFITS OR PRODUCTION OR COMMERCIAL LOSS IN ANY WAY CONNECTED WITH THE PRODUCT, WHETHER SUCH CLAIM IS BASED IN CONTRACT, WARRANTY, NEGLIGENCE, OR STRICT LIABILITY. Further, in no event shall the liability of Horizon exceed the individual price of the Product on which liability is asserted. As Horizon has no control over use, setup, final assembly, modification or misuse, no liability shall be assumed nor accepted for any resulting damage or injury. By the act of use, setup or assembly, the user accepts all resulting liability.

If you as the Purchaser or user are not prepared to accept the liability associated with the use of this Product, you are advised to return this Product immediately in new and unused condition to the place of purchase.

Law: These Terms are governed by Illinois law (without regard to conflict of law principals).

SAFETY PRECAUTIONS

This is a sophisticated hobby Product and not a toy. It must be operated with caution and common sense and requires some basic mechanical ability. Failure to operate this Product in a safe and responsible manner could result in injury or damage to the Product or other property. This Product is not intended for use by children without direct adult supervision. The Product manual contains instructions for safety, operation and maintenance. It is essential to read and follow all the instructions and warnings in the manual, prior to assembly, setup or use, in order to operate correctly and avoid damage or injury.

QUESTIONS, ASSISTANCE, AND REPAIRS

Your local hobby store and/or place of purchase cannot provide warranty support or repair. Once assembly, setup or use of the Product has been started, you must contact Horizon directly. This will enable Horizon to better answer your questions and service you in the event that you may need any assistance. For questions or assistance, please direct your email to productsupport@horizonhobby.com, or call 877.504.0233 toll free to speak to a service technician.

INSPECTION OR REPAIRS

If this Product needs to be inspected or repaired, please call for a Return Merchandise Authorization (RMA). Pack the Product securely using a shipping carton. Please note that original boxes may be included, but are not designed to withstand the rigors of shipping without additional protection. Ship via a carrier that provides tracking and insurance for lost or damaged parcels, as Horizon is not responsible for merchandise until it arrives and is accepted at our facility. A Service Repair Request is available at www.horizonhobby.com on the "Support" tab. If you do not have internet access, please include a letter with your complete name, street address, email address and phone number where you can be reached during business days, your RMA number, a list of the included items, method of payment for any non-warranty expenses and a brief summary of the problem. Your original sales receipt must also be included for warranty consideration. Be sure your name, address, and RMA number are clearly written on the outside of the shipping carton.

WARRANTY INSPECTION AND REPAIRS

To receive warranty service, you must include your original sales receipt verifying the proof-of-purchase date. Provided warranty conditions have been met, your Product will be repaired or replaced free of charge. Repair or replacement decisions are at the sole discretion of Horizon Hobby.

NON-WARRANTY REPAIRS

Should your repair not be covered by warranty the repair will be completed and payment will be required without notification or estimate of the expense unless the expense exceeds 50% of the retail purchase cost. By submitting the item for repair you are agreeing to payment of the repair without notification. Repair estimates are available upon request. You must include this request with your repair. Non-warranty repair estimates will be billed a minimum of 1/2 hour of labor. In addition you will be billed for return freight. Please advise us of your preferred method of payment. Horizon accepts money orders and cashiers checks, as well as Visa, MasterCard, American Express, and Discover cards. If you choose to pay by credit card, please include your credit card number and expiration date. Any repair left unpaid or unclaimed after 90 days will be considered abandoned and will be disposed of accordingly. Please note: non-warranty repair is only available on electronics and model engines.

United States:

Electronics and engines requiring inspection or repair should be shipped to the following address:

Horizon Service Center
4105 Fieldstone Road
Champaign, Illinois 61822

All other Products requiring warranty inspection or repair should be shipped to the following address:

Horizon Product Support
4105 Fieldstone Road
Champaign, Illinois 61822

Please call 877-504-0233 or e-mail us at productsupport@horizonhobby.com with any questions or concerns regarding this product or warranty.

United Kingdom:

Electronics and engines requiring inspection or repair should be shipped to the following address:

Horizon Hobby UK
Units 1-4 Ployters Rd
Staple Tye
Harlow, Essex
CM18 7NS
United Kingdom

Please call +44 (0) 1279 641 097 or e-mail us at sales@horizonhobby.co.uk with any questions or concerns regarding this product or warranty.

Germany:

Electronics and engines requiring inspection or repair should be shipped to the following address:

Horizon Technischer Service
Hamburger Strasse 10
25335 Elmshorn
Germany

Please call +49 4121 46199 66 or e-mail us at service@horizonhobby.de with any questions or concerns regarding this product or warranty.

CE Compliance Information for the European Union

Instructions for Disposal of WEEE by Users in the European Union

This product must not be disposed of with other waste. Instead, it is the user's responsibility to dispose of their waste equipment by handing it over to a designated collection point for the recycling of waste electrical and electronic equipment. The separate collection and recycling of your waste equipment at the time of disposal will help to conserve natural resources and ensure that it is recycled in a manner that protects human health and the environment. For more information about where you can drop off your waste equipment for recycling, please contact your local city office, your household waste disposal service or where you purchased the product.



The associated regulatory agencies of the following countries recognize the noted certifications for this product as authorized for sale and use:

UK	DE	DK	NO	SE
FI	EE	LV	LT	PL
CZ	SK	HU	RO	SI
AT	IT	ES	PT	IE
NL	LU	MT	CY	GR

2008 Official Academy of Model Aeronautics Safety Code

GENERAL

1. A model aircraft shall be defined as a non-human-carrying device capable of sustained flight in the atmosphere. It shall not exceed limitations established in this code and is intended to be used exclusively for recreational or competition activity.
2. The maximum takeoff weight of a model aircraft, including fuel, is 55 pounds, except for those flown under the AMA Experimental Aircraft Rules.
3. I will abide by this Safety Code and all rules established for the flying site I use. I will not willfully fly my model aircraft in a reckless and/or dangerous manner.
4. I will not fly my model aircraft in sanctioned events, air shows, or model demonstrations until it has been proven airworthy.
5. I will not fly my model aircraft higher than approximately 400 feet above ground level, when within three (3) miles of an airport without notifying the airport operator. I will yield the right-of-way and avoid flying in the proximity of full-scale aircraft, utilizing a spotter when appropriate.
6. I will not fly my model aircraft unless it is identified with my name and address, or AMA number, inside or affixed to the outside of the model aircraft. This does not apply to model aircraft flown indoors.
7. I will not operate model aircraft with metal-blade propellers or with gaseous boosts (other than air), nor will I operate model aircraft with fuels containing tetranitromethane or hydrazine.

8. I will not operate model aircraft carrying pyrotechnic devices which explode burn, or propel a projectile of any kind. Exceptions include Free Flight fuses or devices that burn producing smoke and are securely attached to the model aircraft during flight. Rocket motors up to a G-series size may be used, provided they remain firmly attached to the model aircraft during flight. Model rockets may be flown in accordance with the National Model Rocketry Safety Code; however, they may not be launched from model aircraft. Officially designated AMA Air Show Teams (AST) are authorized to use devices and practices as defined within the Air Show Advisory Committee Document.
9. I will not operate my model aircraft while under the influence of alcohol or within eight (8) hours of having consumed alcohol.
10. I will not operate my model aircraft while using any drug which could adversely affect my ability to safely control my model aircraft.
11. Children under six (6) years old are only allowed on a flightline or in a flight area as a pilot or while under flight instruction.
12. When and where required by rule, helmets must be properly worn and fastened. They must be OSHA, DOT, ANSI, SNELL or NOCSAE approved or comply with comparable standards.

RADIO CONTROL

1. All model flying shall be conducted in a manner to avoid over flight of unprotected people.
2. I will have completed a successful radio equipment ground-range check before the first flight of a new or repaired model aircraft.
3. I will not fly my model aircraft in the presence of spectators until I become a proficient flier, unless I am assisted by an experienced pilot.

4. At all flying sites a line must be established, in front of which all flying takes place. Only personnel associated with flying the model aircraft are allowed at or in front of the line. In the case of airshows demonstrations straight line must be established. An area away from the line must be maintained for spectators. Intentional flying behind the line is prohibited.
5. I will operate my model aircraft using only radio-control frequencies currently allowed by the Federal Communications Commission (FCC). Only individuals properly licensed by the FCC are authorized to operate equipment on Amateur Band frequencies.
6. I will not knowingly operate my model aircraft within three (3) miles of any preexisting flying site without a frequency-management agreement. A frequency management agreement may be an allocation of frequencies for each site, a day-use agreement between sites, or testing which determines that no interference exists. A frequency-management agreement may exist between two or more AMA chartered clubs, AMA clubs and individual AMA members, or individual AMA members. Frequency-management agreements, including an interference test report if the agreement indicates no interference exists, will be signed by all parties and copies provided to AMA Headquarters.
7. With the exception of events flown under official AMA rules, no powered model may be flown outdoors closer than 25 feet to any individual, except for the pilot and located at the flightline.
8. Under no circumstances may a pilot or other person touch a model aircraft in flight while it is still under power, except to divert it from striking an individual.
9. Radio-controlled night flying is limited to low-performance model aircraft (less than 100 mph). The model aircraft must be equipped with a lighting system which clearly defines the aircraft's attitude and direction at all times.

10. The operator of a radio-controlled model aircraft shall control it during the entire flight, maintaining visual contact without enhancement other than by corrective lenses that are prescribed for the pilot. No model aircraft shall be equipped with devices which allow it to be flown to a selected location which is beyond the visual range of the pilot.

4-Site Safe Operating Recommendations

- Inspect your model before every flight to make certain it is airworthy.
- Be aware of any other radio frequency user who may present an interference problem.
- Always be courteous and respectful of other users of your selected flight area.
- Choose an area clear of obstacles and large enough to safely accommodate your flying activity.
- Make certain this area is clear of friends and spectators prior to launching your aircraft.
- Be aware of other activities in the vicinity of your flight path that could cause potential conflict.
- Carefully plan your flight path prior to launch.
- Abide by any and all established AMA National Model Aircraft Safety Code.



© 2009 Horizon Hobby, Inc.
4105 Fieldstone Road
Champaign, Illinois 61822
(877) 504-0233
horizonhobby.com
E-fliteRC.com