

BLADE

TORRENT™

110

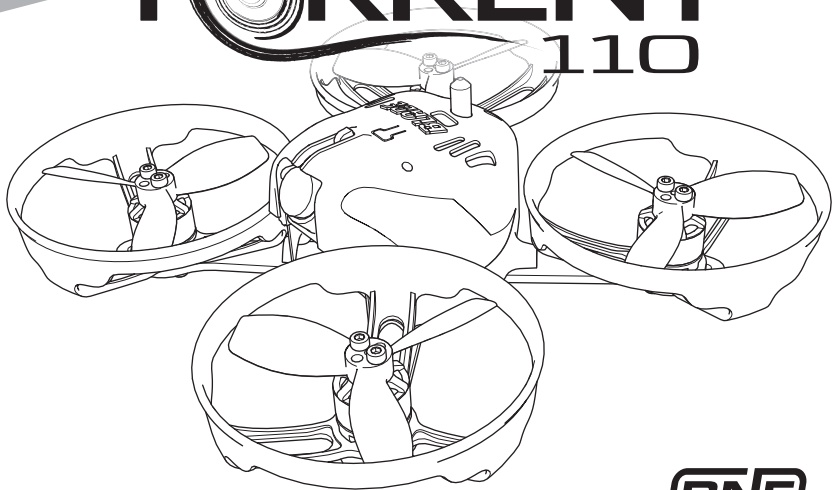

Instruction Manual
Bedienungsanleitung
Manuel d'utilisation
Manuale di Istruzioni

BNF
BASIC

NOTICE

All instructions, warranties and other collateral documents are subject to change at the sole discretion of Horizon Hobby, LLC. For up-to-date product literature, visit www.horizonhobby.com and click on the support tab for this product.

Meaning of Special Language

The following terms are used throughout the product literature to indicate various levels of potential harm when operating this product:

NOTICE: Procedures, which if not properly followed, create a possibility of physical property damage AND a little or no possibility of injury.

CAUTION: Procedures, which if not properly followed, create the probability of physical property damage AND a possibility of serious injury.

WARNING: Procedures, which if not properly followed, create the probability of property damage, collateral damage, and serious injury OR create a high probability of superficial injury.



WARNING: Read the ENTIRE instruction manual to become familiar with the features of the product before operating. Failure to operate the product correctly can result in damage to the product, personal property and cause serious injury.

This is a sophisticated hobby product. It must be operated with caution and common sense and requires some basic mechanical ability. Failure to operate this Product in a safe and responsible manner could result in injury or damage to the product or other property. This product is not intended for use by children without direct adult supervision. Do not use with incompatible components or alter this product in any way outside of the instructions provided by Horizon Hobby, LLC. This manual contains instructions for safety, operation and maintenance. It is essential to read and follow all the instructions and warnings in the manual, prior to assembly, setup or use, in order to operate correctly and avoid damage or serious injury.

Age Recommendation: Not for children under 14 years. This is not a toy.

Safety Precautions and Warnings

- Always keep a safe distance in all directions around your model to avoid collisions or injury. This model is controlled by a radio signal subject to interference from many sources outside your control. Interference can cause momentary loss of control.
- Always operate your model in open spaces away from full-size vehicles, traffic and people.
- Always carefully follow the directions and warnings for this and any optional support equipment (chargers, rechargeable battery packs, etc.).
- Always keep all chemicals, small parts and anything electrical out of the reach of children.
- Always avoid water exposure to all equipment not specifically designed and protected for this purpose. Moisture causes damage to electronics.
- Never place any portion of the model in your mouth as it could cause serious injury or even death.
- Never operate your model with low transmitter batteries.
- Always keep aircraft in sight and under control.
- Always move the throttle fully down at rotor strike.
- Always use fully charged batteries.
- Always keep transmitter powered on while aircraft is powered.
- Always remove batteries before disassembly.
- Always keep moving parts clean.
- Always keep parts dry.
- Always let parts cool after use before touching.
- Always remove batteries after use.
- Never operate aircraft with damaged wiring.
- Never touch moving parts.



WARNING AGAINST COUNTERFEIT PRODUCTS: If you ever need to replace a Spektrum component found in a Horizon Hobby product, always purchase from Horizon Hobby, LLC or a Horizon Hobby authorized dealer to ensure authentic high-quality Spektrum product. Horizon Hobby, LLC disclaims all support and warranty with regards, but not limited to, compatibility and performance of counterfeit products or products claiming compatibility with DSM or Spektrum technology.

If you are operating this product in North America, you are required to have an Amateur Radio (HAM) license. Visit www.arrl.org for more information.

This product uses Betaflight Third Party Software in portions of its coding. For more information on Betaflight Software, please visit: <https://github.com/betaflight/betaflight/wiki>.

THIRD PARTY SOFTWARE. This product may include code developed by one or more third parties (“Third Party Software”). Some Third Party Software may be subject to other terms and conditions that may be available for download with the product documentation. Notwithstanding the terms and conditions of this Agreement, the Third Party Software is licensed to you subject to the terms and conditions of the software license agreement identified in the open source software disclosure. If the third party terms and conditions include licenses that provide for the availability of source code (such as the GNU General Public License), the open source software disclosure or the media on which the software may be delivered will provide instructions where a copy of such source code can be obtained.

Table of Contents

First Flight Preparation.....	6	Post-Flight Inspection	
Flying Checklist	6	and Maintenance Checklist.....	16
Installing the Propellers.....	6	Troubleshooting Guide	16
Transmitter Setup	7	Parts Explosion	19
Installing the Flight Battery	8	Parts Listings.....	19
Transmitter and Receiver Binding.....	9	Optional Parts	19
Understanding the Primary Flight Controls	10	Limited Warranty	20
Using the Video Transmitter.....	12	Warranty and Service Contact Information	22
Adjusting the FPV Camera Angle	13	FCC Information.....	23
Preparing the Torrent Quadcopter for Flight.....	14	IC Information	23
Flight Mode and Rate Selection.....	14	Compliance Information	
Flying the Torrent Quadcopter	15	for the European Union	24

Specifications

Length	3.93 in (100mm)	Max Propeller Diameter	2 in (50.80mm)
Height	1.57 in (40mm)	Flying Weight	4.23 oz (120g)

Box Contents:

- Torrent™ BNF Basic Quadcopter
 - Spektrum™ Quad Race Serial Receiver w/telemetry
 - 4-n-1 FPV ESC
 - Flight Controller
 - 150mW Video Transmitter, included in BLH04050 (North America)
 - 25mW Video Transmitter, included in BLH04050EU (Europe)
 - FPV Camera

Needed to Complete:

- DSM2®/DSMX® Compatible Transmitter
- 2S 800mAh or 3S 450mAh LiPo Battery
- LiPo Compatible Battery Charger
- FPV Headset or Groundstation Monitor

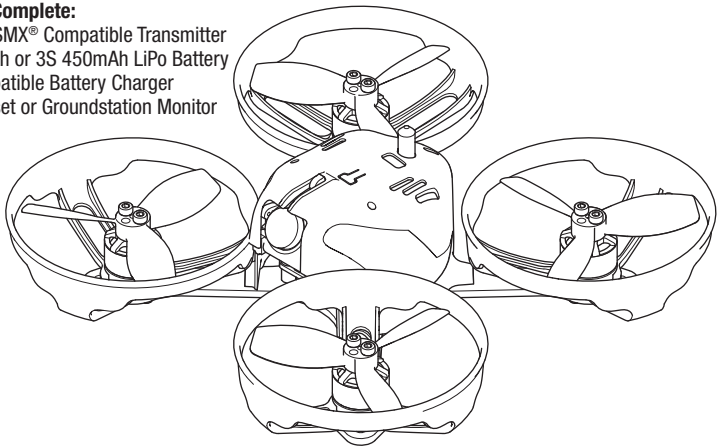

To receive product updates, special offers and more, register your product at www.bladehelis.com.

NOTICE: Consult local laws and ordinances before operating FPV (first person view) equipment. In some areas, FPV operation may be limited or prohibited. You are responsible for operating this product in a legal and responsible manner.

First Flight Preparation

- Remove and inspect contents
- Begin charging the flight battery
- Assemble the aircraft
- Program your computer transmitter
- Install the flight battery in the aircraft (once it has been fully charged)
- Bind your transmitter
- Familiarize yourself with the controls
- Find a suitable area for flying

Installing the Propellers

1. Refer to the illustration for the proper motor rotation and propeller location.
2. The propellers have an “A” or “B” marked on one blade. Match the propeller location to the illustration.
3. Secure the propellers using 2 socket head screws per propeller. **Do not** overtighten the screws as damage to the propellers or motors may result.

Flying Checklist

- Always turn the transmitter on first**
- Plug the flight battery into the lead from the ESC
- Allow the ESC to initialize and arm properly
- Fly the model
- Land the model
- Unplug the flight battery from the ESC
- Always turn the transmitter off last**

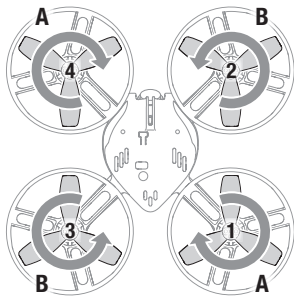

Transmitter Setup

DX6, DX7 (Gen 2), DX8 (Gen 2), DX9, DX18, DX20

SETUP LIST

Model Type	
Airplane	

F-Mode Setup

Switch 1	Inhibit
Switch 2	Inhibit

Channel Assign

Channel Input Config

1 Throttle	
2 Aileron	
3 Elevator	
4 Rudder	
5 Gear	Switch B
6 Aux 1	Switch H

Frame Rate

11ms
DSMX

FUNCTION LIST

Servo Setup

Chan	Travel	Reverse
THR	150/150	Normal
AIL	148/148	Reverse
ELE	148/148	Normal
RUD	148/148	Reverse
GER	100/100	Normal
AUX1	100/100	Normal

Timer

Mode	Count Down
Time	3:00
Start	Throttle Out
Over	25%
One Time	Inhibit

D/R & Expo

Chan	Switch (B)		
	Pos	D/R	Expo
AILE	0	100/100	0
	1	100/100	0
	2	100/100	0
ELEV	0	100/100	0
	1	100/100	0
	2	100/100	0

Switch Functions

Flight Mode Switch = **Switch B**

Motor Arm Switch = **Switch H**

For telemetry setup information, refer to your transmitter manual or www.spektrumrc.com.

Installing the Flight Battery

1. Set the motor arm switch to OFF (position 1).
2. Lower the throttle.
3. Power on the transmitter.
4. Attach hook material to the quadcopter frame and loop material to the battery.
5. Install the flight battery on the quadcopter frame and secure it with the hook and loop strap.
6. Connect the battery cable to the aircraft power lead, noting correct polarity.



CAUTION: Connecting the battery to the aircraft power lead with reversed polarity will cause damage to the power distribution board, ESCs and the battery. Damage caused by incorrectly connecting the battery is not covered under warranty.

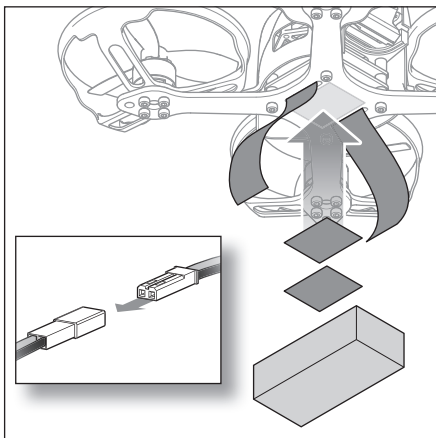

Do not move the quadcopter until the receiver initializes.

7. The quadcopter motors will emit initialization tones, indicating the ESC is armed.



CAUTION: Always disconnect the Li-Po battery from the quadcopter when not flying to avoid over-discharging the battery. Batteries discharged to a voltage lower than the lowest approved voltage may become damaged, resulting in loss of performance and potential fire when batteries are charged.

Transmitter and Receiver Binding

To bind or re-bind your quadcopter to your chosen transmitter, follow the directions below.

Binding Procedure

1. Select the correct model in your transmitter.
2. Power off your transmitter.
3. Lower the throttle fully.
4. Power the quadcopter on while pressing the bind button located on the flight control board below the camera, as shown in the illustration.
5. Follow the procedures of your specific transmitter to enter Bind Mode.
6. The receiver LED glows solid orange indicating binding was successful.

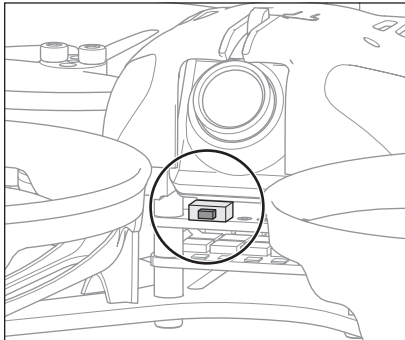

If you encounter problems, obey binding instructions and refer to the troubleshooting guide for other instructions.

If needed, contact the appropriate Horizon Product Support office. For a list of compatible DSM® transmitters, please visit www.bindnfly.com.

Failsafe

The included receiver does not have failsafe capabilities. Failsafe is detected at the flight controller. In the event of a loss of signal to the receiver the flight controller will cut power to the motors to prevent a fly-away situation.

Understanding the Primary Flight Controls

If you are not familiar with the controls of your quadcopter, take a few minutes to familiarize yourself with them before attempting your first flight.

Throttle

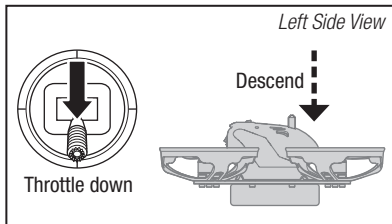
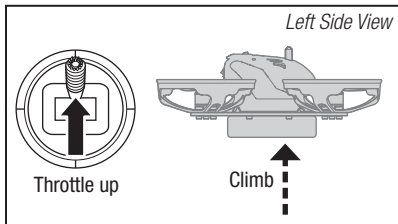

Rudder

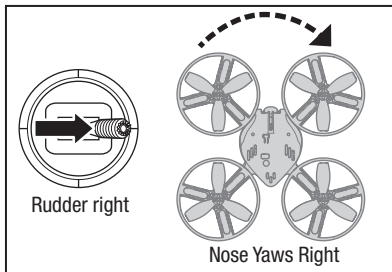
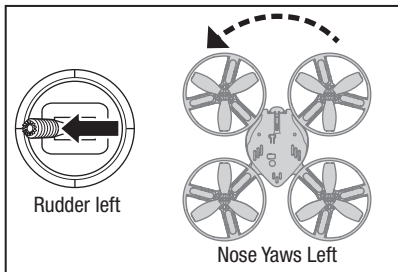

Elevator

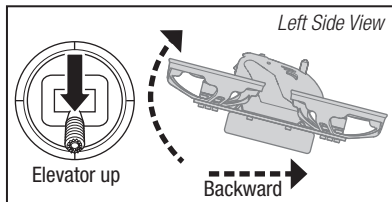
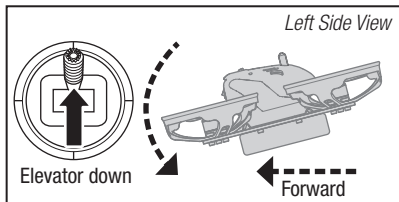

Aileron

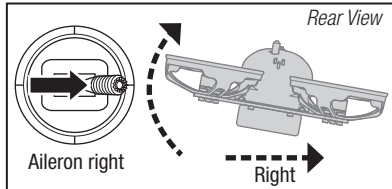
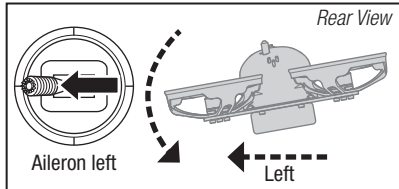

Using the Video Transmitter

Consult local laws and ordinances before operating FPV equipment. In some areas, FPV operation may be limited or prohibited. You are responsible for operating this product in a legal and responsible manner.

See the Available Frequency table to find the desired video channel and band. The video transmitter channel and band are changed using the button on the top of the quadcopter, as shown. There are 6 LEDs on the video transmitter board. The red LED is the channel indicator. The next 5 blue LEDs are the band indicators.

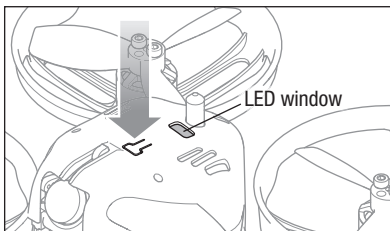

IMPORTANT: The 25mW video transmitter included with the European Union version of the Torrent (BL-H04050EU) has 4 blue LEDs. Band E is not available on this version.

Channel Selection:

1. Channel 1 is indicated by the red LED glowing solid.
2. Press the button to cycle through the channels (1-8). The red LED will flash once as you cycle through each channel. Press the button once for each channel until the desired channel is reached. If unsure of the current transmitter channel, press the button to cycle the channels until you reach channel 1, indicated by a solid red LED, then cycle to the channel desired.

Band Selection:

1. Press and hold the button to change the video transmitter band.
2. Each time the button is pressed and held, the blue band LED will indicate a change to the next available band. The blue LEDs indicate FS/IRC band, band E (North America only), band A, race band and band B, in that order as shown in the illustration.

Video Transmitter LEDs

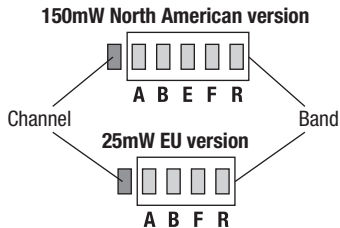

Available Frequencies, North America (mHz)

Band	CH 1	CH 2	CH 3	CH 4	CH 5	CH 6	CH 7	CH 8
Band A	5865	5845	5825	5805	5785	5765	5745	5725
Band B	5733	5752	5771	5790	5809	5828	5847	5866
Band E	5705	5685	5665	5665	5885	5905	5905	5905
FS/IRC	5740	5760	5780	5800	5820	5840	5860	5880
RaceBand	5658	5695	5732	5769	5806	5843	5880	5917

Available Frequencies, European Union (mHz)

Band	CH 1	CH 2	CH 3	CH 4	CH 5	CH 6	CH 7	CH 8
Band A	5865	5845	5825	5805	5785	5765	5745	5745
Band B	5733	5752	5771	5790	5809	5828	5847	5866
FS/IRC	5740	5760	5780	5800	5820	5840	5860	5860
RaceBand	5732	5732	5732	5769	5806	5843	5843	5843

Adjusting the FPV Camera Angle

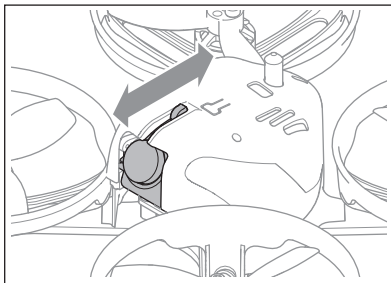

The angle of the FPV camera is adjusted by moving the small lever on the top of the quadcopter forward or backward until the desired angle is achieved as shown in the illustration.

Preparing the Torrent Quadcopter for Flight

1. Before each flight, ALWAYS power on the transmitter before connecting the flight battery to the quadcopter. After each flight, disconnect the flight battery from the quadcopter before powering off the transmitter.

NOTICE: Connecting the flight battery before powering on the transmitter can start the binding process. Please see the *Transmitter and Receiver Binding* section of this manual for more information.

2. When the ESC beeps, the flight controller is initialized and ready for flight.

The flight controller will not arm the motors until the throttle stick is in the lowest possible position.

Flight Mode and Rate Selection

- In angle mode (*switch position 0*), the quadcopter will self-level and has a bank angle limit of approximately 60 degrees.
- In air mode (*switch position 1*), the quadcopter will not self-level and does not have a bank angle limit. At low throttle, the flight controller will continue to stabilize the quadcopter to hold whatever attitude was last commanded. This mode is useful for flying smooth aerobatic maneuvers at both high and low throttle settings.
- In acro mode (*switch position 2*), the quadcopter will not self-level and does not have a bank angle limit. At low throttle, the flight controller will not stabilize the quadcopter. The pilot must actively control the quadcopter to maintain a desired attitude. This mode is most preferred when immediate changes in altitude are desired, such as in racing. Use rates and expo to tune the performance according to your flying style.

Refer to the *Transmitter Setup* for transmitter switch selection and specific setup information.

Flying the Torrent Quadcopter

Takeoff

When you are prepared to fly, start the motors by activating the motor arm switch (switch H), as programmed in the transmitter setup section. Increase the throttle until the model is approximately 2 ft. (600mm) off the ground and check the trim so the model flies as desired. Once the trim is adjusted, begin flying the model.

Flight times for the included battery will vary according to how aggressively the throttle is used.

Low Voltage Cutoff (LVC)

LVC decreases the power to the motors when the battery voltage gets low. When the motor power decreases, land the aircraft immediately and recharge the flight battery.

LVC does not prevent the battery from over-discharge during storage.

NOTICE: Repeated flying to LVC will damage the battery.

Landing

To land, slowly decrease the throttle while in a low-level hover. After landing, stop the motors by changing the motor arm switch to the off position; disconnect and remove the battery from the aircraft after use to prevent over discharge. During storage, make sure the battery charge does not fall below 3V per cell.

Post-Flight Inspection and Maintenance Checklist



WARNING: Remove the propellers from the motors prior to performing any troubleshooting or maintenance. Failure to do so may cause serious injury if the motors start unexpectedly.



Cleaning	Make sure the battery is not connected before cleaning. Remove dust and debris with a soft brush or a dry, lint-free cloth.
Motors	Replace the motor when the model will not fly steady or veers off when doing a climb out.
Wiring	Make sure the wiring does not block moving parts. Replace damaged wiring and loose connectors.
Fasteners	Make sure there are no loose screws, other fasteners or connectors. Do not over-tighten metal screws in plastic parts. Tighten screws so the parts are mated together, then turn the screw only 1/8th of a turn more. Do not use threadlock on or near plastic parts.
Propellers	Make sure there is no damage to the propellers or other parts that move at high speed. Damage to these parts includes cracks, burrs, chips or scratches. Replace damaged parts before flying.

Troubleshooting Guide



WARNING: Remove the propellers from the motors prior to performing any troubleshooting or maintenance. Failure to do so may cause serious injury if the motors start unexpectedly.

Problem	Possible Cause	Solution
Quadcopter control response is inconsistent or requires extra trim to neutralize movement	Quadcopter not initialized on a level surface	Disconnect the flight battery, center the control trim and re-initialize the quadcopter
	Battery not correctly placed	Adjust battery position so quadcopter balances in the center of the frame

Problem	Possible Cause	Solution
Quadcopter will not respond to throttle	Motor arm switch is in the OFF position	Set the motor arm switch to the ON position
	Throttle too high and/or throttle trim is too high	Reset controls with the throttle stick and throttle trim at the lowest setting
	Quadcopter moved during initialization	Disconnect the flight battery and re-initialize the quadcopter while keeping the quadcopter from moving
	Throttle channel is reversed	Disconnect flight battery, reverse the throttle channel on the transmitter, reconnect flight battery
Quadcopter does not function and smells burnt after connecting the flight battery	Flight battery connected with the wrong polarity	Replace the power distribution board. Connect the flight battery noting proper polarity
Quadcopter has reduced flight time or is underpowered	Flight battery charge is low	Completely recharge the flight battery
	Inadequate power to flight battery charger	Use a different power source for the charger
	Flight battery is damaged	Replace the flight battery and follow the flight battery instructions
	Flight conditions might be too cold	Make sure the battery is warm (room temperature) before use
Crashes immediately upon lift-off	Propellers in wrong locations or incorrect flight mode selected	Ensure propeller direction and motor direction are correct
	Aileron, elevator or rudder are reversed in the transmitter	Ensure aileron, elevator or rudder are not reversed

Problem	Possible Cause	Solution
Difficulty binding	Bind button not pressed while powering on the quadcopter	Power off quadcopter and repeat bind process
	Bind switch or button was not held while transmitter was powered on	Power off transmitter and repeat bind process
	Transmitter too near aircraft during binding process	Power off the transmitter. Move the transmitter a larger distance from the aircraft or shield the aircraft from the transmitter using your body. Disconnect and reconnect the flight battery to the quadcopter. Follow the binding instructions
	Quadcopter or transmitter is too close to large metal object, wireless source or another transmitter	Move quadcopter and transmitter to another location and attempt binding again
Difficulty connecting (after binding)	Transmitter not powered on before the quadcopter	Power the quadcopter off. Power on the transmitter first and then the quadcopter.
	Less than a 5-second wait between first powering on the transmitter and connecting the flight battery to the quadcopter	Leave the transmitter powered on. Disconnect and reconnect the flight battery to the quadcopter
	The quadcopter is bound to a different model memory (ModelMatch™ transmitters only)	Select the correct model memory on the transmitter. Disconnect and reconnect the flight battery to the quadcopter
	Flight battery or transmitter battery charge is too low	Replace or recharge batteries
	Quadcopter or transmitter is too close to large metal object, wireless source or another transmitter	Move quadcopter and transmitter to another location and attempt connecting again

Parts Explosion

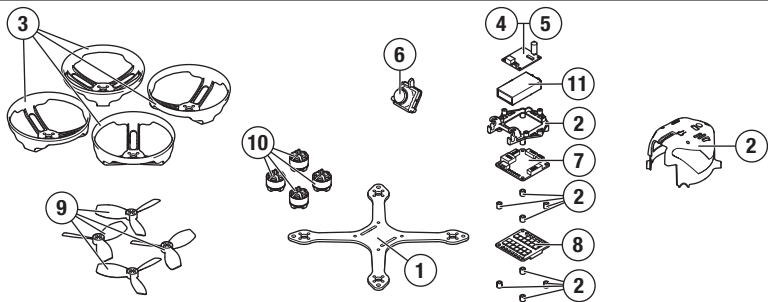

Parts Listings

Part #	Description	Part #	Description
1	BLH04001 Carbon Frame	7	SPMFCMF300 Flight Control, F3
2	BLH04002 Body/Camera Mount	8	BLH04008 4-n-1 FPV ESC, BLHeli
3	BLH04003 Prop Guards (4)	9	BLH04009 2" FPV Propellers
4	SPMVTM150 150mW Video Transmitter	10	BLHA1024 1104-7600Kv FPV Racing Motor
5	SPMVTM025 25mW Video Transmitter	11	SPM4649T Spektrum Quad Race Serial Receiver w/telemetry
6	SPMVCM01 FPV Camera		

Optional Parts

Part #	Description	Part #	Description
EFLB4503SJ30	450mAh 3S 11.1V 30C LiPo Battery	SPMVR2510	Focal V2 FPV Wireless Headset with Diversity
EFLB8002SJ30	800mAh 2S 7.4V 30C LiPo Battery	SPMM430C	Spektrum 4.3 inch Video Monitor with Headset
FSV1063	Dominator V3 Modular WGA Headset		
FSV1076	Fat Shark Dominator HD3 Headset		

Limited Warranty

What this Warranty Covers

Horizon Hobby, LLC, (Horizon) warrants to the original purchaser that the product purchased (the "Product") will be free from defects in materials and workmanship at the date of purchase.

What is Not Covered

This warranty is not transferable and does not cover (i) cosmetic damage, (ii) damage due to acts of God, accident, misuse, abuse, negligence, commercial use, or due to improper use, installation, operation or maintenance, (iii) modification of or to any part of the Product, (iv) attempted service by anyone other than a Horizon Hobby authorized service center, (v) Product not purchased from an authorized Horizon dealer, (vi) Product not compliant with applicable technical regulations, or (vii) use that violates any applicable laws, rules, or regulations.

OTHER THAN THE EXPRESS WARRANTY ABOVE, HORIZON MAKES NO OTHER WARRANTY OR REPRESENTATION, AND HEREBY DISCLAIMS ANY AND ALL IMPLIED WARRANTIES, INCLUDING, WITHOUT LIMITATION, THE IMPLIED WARRANTIES OF NON-INFRINGEMENT, MERCHANTABILITY AND FITNESS FOR A PARTICULAR PURPOSE. THE PURCHASER ACKNOWLEDGES THAT THEY ALONE HAVE DETERMINED THAT THE PRODUCT WILL SUITABLY MEET THE REQUIREMENTS OF THE PURCHASER'S INTENDED USE.

Purchaser's Remedy

Horizon's sole obligation and purchaser's sole and exclusive remedy shall be that Horizon will, at its option, either (i) service, or (ii) replace, any Product determined by Horizon to be defective. Horizon reserves the right to inspect any and all Product(s) involved in a warranty claim. Service or replacement decisions are at the sole discretion of Horizon.

Proof of purchase is required for all warranty claims. SERVICE OR REPLACEMENT AS PROVIDED UNDER THIS WARRANTY IS THE PURCHASER'S SOLE AND EXCLUSIVE REMEDY.

Limitation of Liability

HORIZON SHALL NOT BE LIABLE FOR SPECIAL, INDIRECT, INCIDENTAL OR CONSEQUENTIAL DAMAGES, LOSS OF PROFITS OR PRODUCTION OR COMMERCIAL LOSS IN ANY WAY, REGARDLESS OF WHETHER SUCH CLAIM IS BASED IN CONTRACT, WARRANTY, TORT, NEGLIGENCE, STRICT LIABILITY OR ANY OTHER THEORY OF LIABILITY, EVEN IF HORIZON HAS BEEN ADVISED OF THE POSSIBILITY OF SUCH DAMAGES. Further, in no event shall the liability of Horizon exceed the individual price of the Product on which liability is asserted. As Horizon has no control over use, setup, final assembly, modification or misuse, no liability shall be assumed nor accepted for any resulting damage or injury. By the act of use, setup or assembly, the user accepts all resulting liability. If you as the purchaser or user are not prepared to accept the liability associated with the use of the Product, purchaser is advised to return the Product immediately in new and unused condition to the place of purchase.

Law

These terms are governed by Illinois law (without regard to conflict of law principals). This warranty gives you specific legal rights, and you may also have other rights which vary from state to state. Horizon reserves the right to change or modify this warranty at any time without notice.

WARRANTY SERVICES

Questions, Assistance, and Services

Your local hobby store and/or place of purchase cannot provide warranty support or service. Once assembly, setup

or use of the Product has been started, you must contact your local distributor or Horizon directly. This will enable Horizon to better answer your questions and service you in the event that you may need any assistance. For questions or assistance, please visit our website at www.horizon-hobby.com, submit a Product Support Inquiry, or call the toll free telephone number referenced in the Warranty and Service Contact Information section to speak with a Product Support representative.

Inspection or Services

If this Product needs to be inspected or serviced and is compliant in the country you live and use the Product in, please use the Horizon Online Service Request submission process found on our website or call Horizon to obtain a Return Merchandise Authorization (RMA) number. Pack the Product securely using a shipping carton. Please note that original boxes may be included, but are not designed to withstand the rigors of shipping without additional protection. Ship via a carrier that provides tracking and insurance for lost or damaged parcels, as Horizon is not responsible for merchandise until it arrives and is accepted at our facility. An Online Service Request is available at http://www.horizonhobby.com/content/service-center_render-service-center. If you do not have internet access, please contact Horizon Product Support to obtain a RMA number along with instructions for submitting your product for service. When calling Horizon, you will be asked to provide your complete name, street address, email address and phone number where you can be reached during business hours. When sending product into Horizon, please include your RMA number, a list of the included items, and a brief summary of the problem. A copy of your original sales receipt must be included for warranty consideration. Be sure your name, address, and RMA number are clearly written on the outside of the shipping carton.

NOTICE: Do not ship LiPo batteries to Horizon. If you have any issue with a LiPo battery, please contact the appropriate Horizon Product Support office.

Warranty Requirements

For Warranty consideration, you must include your original sales receipt verifying the proof-of-purchase date. Provided warranty conditions have been met, your Product will be serviced or replaced free of charge. Service or replacement decisions are at the sole discretion of Horizon.

Non-Warranty Service

Should your service not be covered by warranty, service will be completed and payment will be required without notification or estimate of the expense unless the expense exceeds 50% of the retail purchase cost. By submitting the item for service you are agreeing to payment of the service without notification. Service estimates are available upon request. You must include this request with your item submitted for service. Non-warranty service estimates will be billed a minimum of ½ hour of labor. In addition you will be billed for return freight. Horizon accepts money orders and cashier's checks, as well as Visa, MasterCard, American Express, and Discover cards. By submitting any item to Horizon for service, you are agreeing to Horizon's Terms and Conditions found on our website http://www.horizon-hobby.com/content/service-center_render-service-center.

ATTENTION: Horizon service is limited to Product compliant in the country of use and ownership. If received, a non-compliant Product will not be serviced. Further, the sender will be responsible for arranging return shipment of the un-serviced Product, through a carrier of the sender's choice and at the sender's expense. Horizon will hold non-compliant Product for a period of 60 days from notification, after which it will be discarded. 10/15

Warranty and Service Contact Information

Country of Purchase	Horizon Hobby	Contact Information	Address
United States of America	Horizon Service Center (Repairs and Repair Requests)	servicecenter.horizonhobby.com/ RequestForm/	4105 Fieldstone Rd Champaign, Illinois, 61822 USA
	Horizon Product Support (Product Technical Assistance)	productsupport@horizonhobby.com 877-504-0233	
	Sales	websales@horizonhobby.com 800-338-4639	
European Union	Horizon Technischer Service	service@horizonhobby.de	Hanskampring 9 D 22885 Barsbüttel, Germany
	Sales: Horizon Hobby GmbH	+49 (0) 4121 2655 100	

FCC Information

FCC ID: BRWAR4649T

This equipment has been tested and found to comply with the limits for Part 15 of the FCC rules. These limits are designed to provide reasonable protection against harmful interference in a residential installation. This equipment generates uses and can radiate radio frequency energy and, if not installed and used in accordance with the instructions, may cause harmful interference to radio communications.

However, there is no guarantee that interference will not occur in a particular installation. If this equipment does cause harmful interference to radio or television reception, which can be determined by turning the equipment off and on, the user is encouraged to try to correct the interference by one or more of the following measures:

- Reorient or relocate the receiving antenna.
- Increase the separation between the equipment and receiver.
- Connect the equipment to an outlet on a circuit different from that to which the receiver is connected.

This device complies with part 15 of the FCC rules. Operation is subject to the following two conditions: (1) This device may not cause harmful interference, and (2) this device must accept any interference received, including interference that may cause undesired operation.

NOTICE: Modifications to this product will void the user's authority to operate this equipment.

IC Information

IC: 6157A-AR4649T

This device complies with Industry Canada licence-exempt RSS standard(s). Operation is subject to the following two conditions: (1) this device may not cause interference, and (2) this device must accept any interference, including interference that may cause undesired operation of the device.”

Compliance Information for the European Union



EU Compliance Statement:

Horizon Hobby, LLC hereby declares that this product is in compliance with the essential requirements and other relevant provisions of the RED and EMC Directives.

A copy of the EU Declaration of Conformity is available online at: <http://www.horizonhobby.com/content/support-render-compliance>.



Instructions for disposal of WEEE by users in the European Union

This product must not be disposed of with other waste. Instead, it is the user's responsibility to dispose of their waste equipment by handing it over to a designated collections point for the recycling of waste electrical and electronic equipment. The separate collection and recycling of your waste equipment at the time of disposal will help to conserve natural resources and make sure that it is recycled in a manner that protects human health and the environment. For more information about where you can drop off your waste equipment for recycling, please contact your local city office, your household waste disposal service or where you purchased the product.



E328

©2017 Horizon Hobby, LLC.

Blade, Torrent, DSM, DSM2, DSMX, Bind-N-Fly, BNF, the BNF logo, ModelMatch, Focal and the Horizon Hobby logo are trademarks or registered trademarks of Horizon Hobby, LLC.

The Spektrum trademark is used with permission of Bachmann Industries, Inc.

All other trademarks, service marks or logos are property of their respective owners.

Created 01/17

55048

BLH04050/BLH04050EU